

Mitsubishi Programmable Controller
Quick Start Guide
MELSEC  series











Let's Start

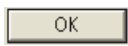

How to read this guide	1
Generic terms	2
Introduction	3
Programmable controllers	4
Introduction of related manuals	5
Using programmable controllers	6
Preparing for Operation	①
System Configuration	②
Mounting Modules	③
Wiring Modules	④
Checking Power Supply	⑤
Programming	⑥
Writing Programs	⑦
Checking Operation	⑧
Troubleshooting	7
Frequently-used functions	8

How to read this guide

The following shows the symbols used in this Quick start guide with descriptions and examples.

Symbol	Description	Example
 Point	This symbol explains information you need to know.	Select [View] → [Comment] ( key +  key). The comment display/hide setting can be switched.
 Reference	This symbol describes the references of manuals and pages for more details.	For details, refer to the following manual.  QnUCPU User's Manual (Function Explanation, Program Fundamentals): SH-080807ENG
 Caution	This symbol describes content that must be noted in operation.	When mounting the module, the power must be turned OFF.
[]	Menu names on the menu bar ([] → [] shows drop-down menus.)	Select [Project] → [New project].
	Buttons on the screen	 button
	Keys on the keyboard	 key
()	Another procedure corresponding to a drop-down menu (icons and keys on the keyboard)	Select [Online] → [Monitor] → [Monitor mode] ( key) ().
< >	Tab names on the screen	<Program common> tab

Generic terms

The following explains the terms used in this Quick start guide.

Generic term	Description
Programmable controller system	Combination of the power supply module, the CPU module, the I/O modules, and the base unit.
Sequence control	Consecutively processes each control step based on the fixed order or procedure.
QnACPU	General term for the programmable controller CPU available in MELSEC-QnA.
GX Developer	Application software to create sequence programs and communicate with the programmable controllers.
CPU module	The core module to unify the controls of the programmable controllers. Q02UCPU is used in this Quick start guide.
Power supply module	Supplies electricity to each module, including the CPU module and the I/O modules.
Base unit	The unit that mounts the power supply module, the CPU module, and the I/O modules.
Building block	A method to organize one system by combining necessary elements. Elements such as the power supply module, the CPU module, the I/O modules, and the base unit are combined in the programmable controller system.
Limit switch	A switch to suspend mobile objects on both sides of a moving apparatus for safety reasons.
Relay	Breaks/connects the electricity with electrical switching.
Contact	Generally called an electromagnetic contactor to break circuits and switch the heater.
Solenoid valve	An electromagnet with a direct/alternating current solenoid valve. Connected to the output side of the programmable controller.
Ground	Prevents electric shocks and malfunctions.
Control panel	Transfers signals to other equipment. Combines such elements as breakers, switches, protection equipment, relays, and programmable controllers. Receives signals from switches and sensors, and supply electricity to operate motors and solenoid valves of the machines and equipment.
Isolation transformer	A two-winding transformer. The primary and secondary coil are wound separately to protect the secondary load.
Contact	An input used when creating a sequence program.
Coil	An output used when creating a sequence program.
Device	A location to store data such as ON/OFF, numeric values, and character strings in the programmable controller.
Internal relay	Breaks/connects the sequence circuit by switching ON/OFF.
Sequence program	A program to perform sequence control.
Project	Indicates a GX Developer project in this Quick start guide. Consists of programs, device comments, and parameters.
Parameter	Setup information necessary to operate the programmable controller system. Modules and the network are set by writing parameters to the CPU module.
PLC parameter	Setup information for modules, devices, and programs used in the programmable controller system.
Step number	Numbers attached in order from the start of instruction in the sequence program.
Logical operations	One of the basic operation methods in programming. Logical operations consist of three basic operations: logical AND, logical OR, and logical NOT.
Debug	An operation in which programmers search for and correct bugs in the sequence program.

Introduction

This Quick start guide explains the basic procedures for the first-time use of the Mitsubishi programmable controller MELSEC-Q series CPU module (CPU module).

You can easily understand how to use the programmable controller with this manual.

Quick start guide

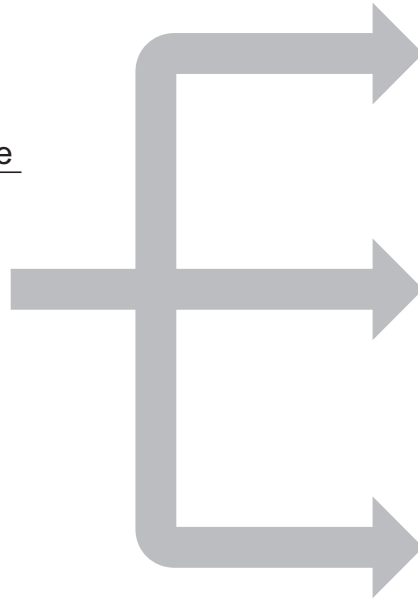
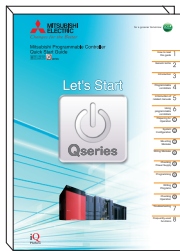

Mounting and wiring modules

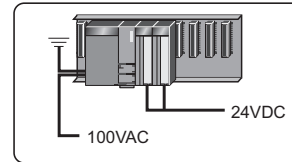

Creating programs

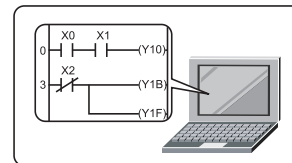

Checking operations

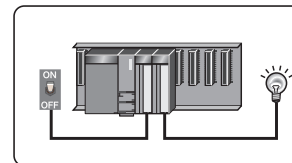

Reference

● Precautions

Read "SAFETY PRECAUTIONS" in the QCPU User's Manual carefully and use the programmable controllers safely.

● Types of CPU modules

This Quick start guide explains the usage examples for Universal model QCPU. For the usage of other CPU modules, refer to the following manuals and be aware of the differences.

☞ QCPU User's Manual (Hardware Design, Maintenance and Inspection): SH-080483ENG

☞ Qn(H)/QnPH/QnPRHCPU User's Manual (Function Explanation, Program Fundamentals): SH-080808ENG

☞ QnUCPU User's Manual (Function Explanation, Program Fundamentals): SH-080807ENG

☞ QCPU Programming Manual (Common Instructions): SH-080809

☞ QnACPU Programming Manual (Common Instructions): SH-080810

⚠ Caution

This Quick start guide explains operations in the programmable controller system described in "② System Configuration" (P.9).

Read the manuals referred in the following page when you design or manage the system.

☞ Introduction of related manuals (P.6)

Programmable controllers

The programmable controllers perform sequence control and logical operations by switching the output of output equipment ON/OFF according to the command signal from the input equipment.

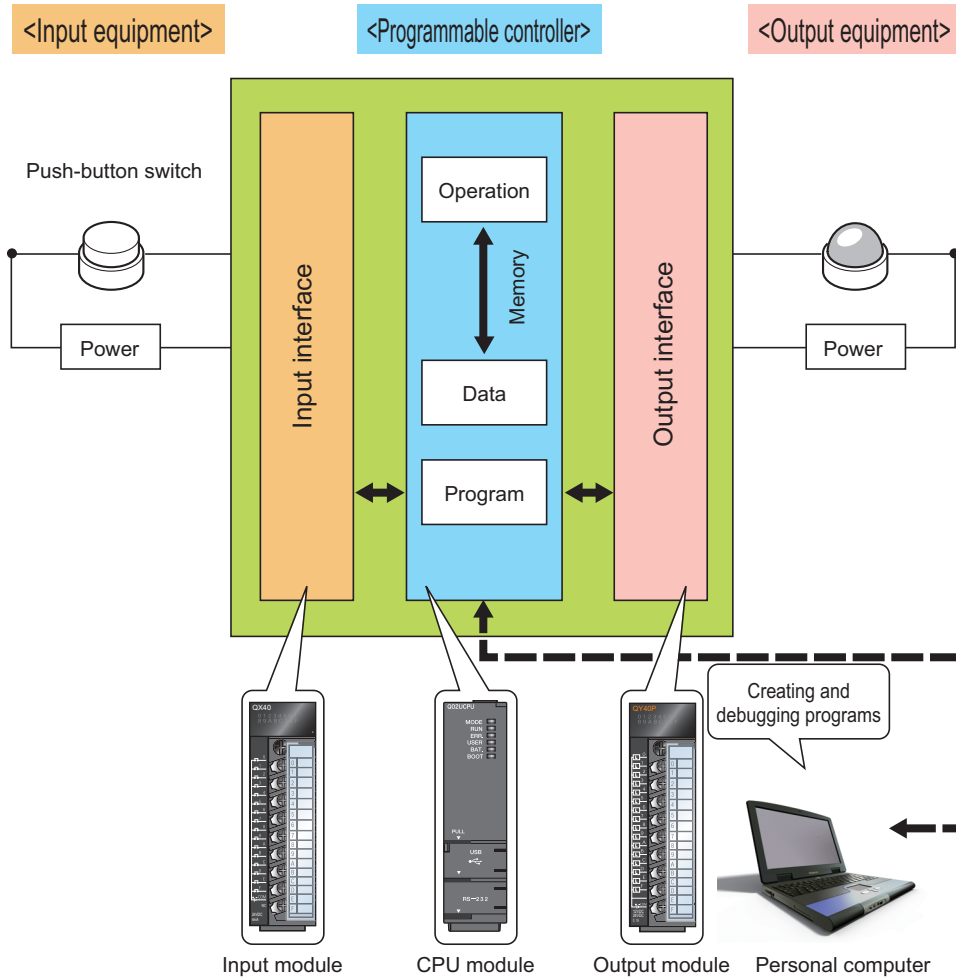

Other equipment is shown below.

<Examples of input equipment>

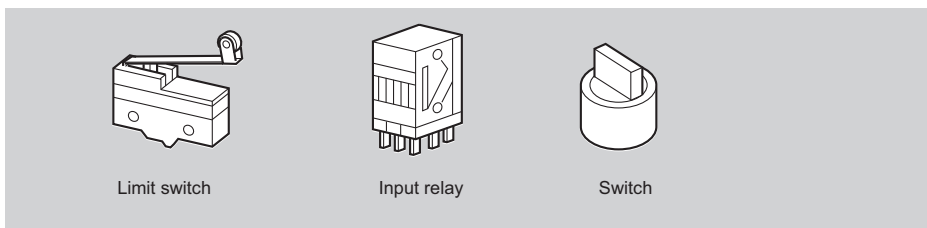

<Examples of output equipment>

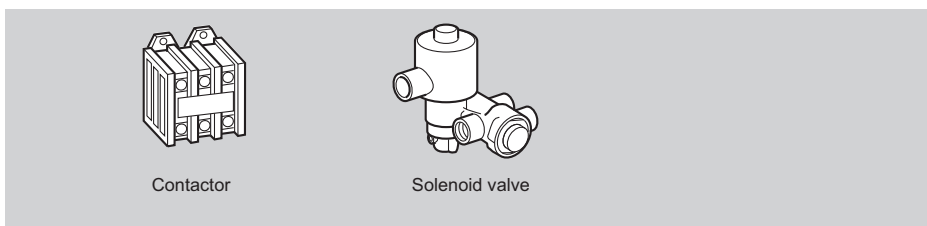

■ Programmable controller usage example

This example shows the programmable controller system in a beverage plant.

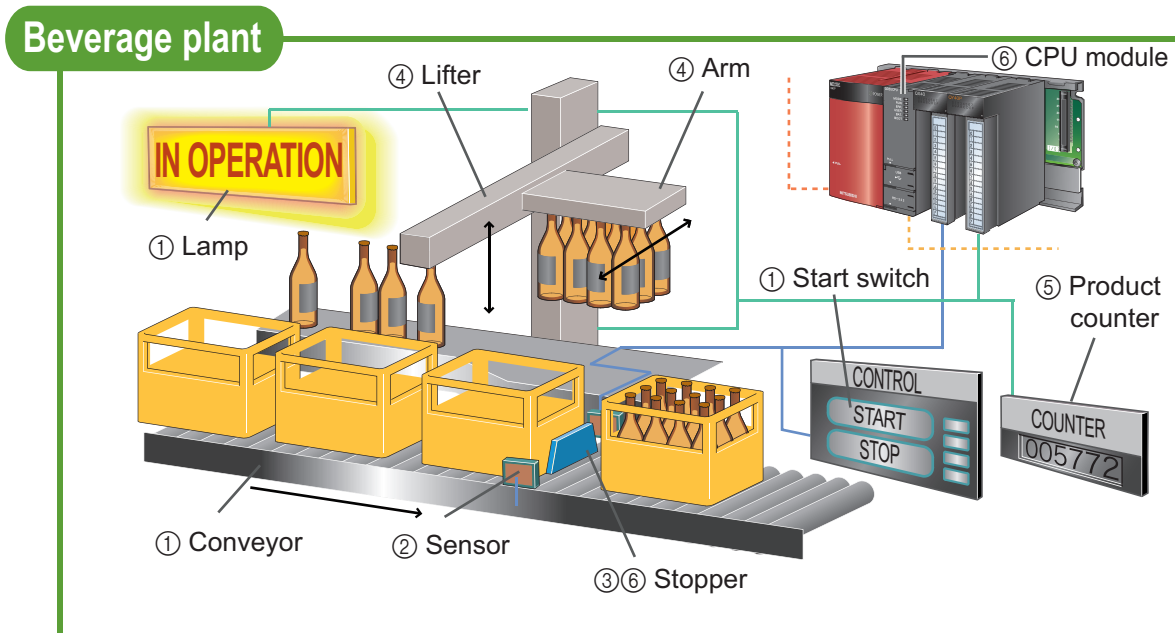

The following explains the procedure for putting bottles in a case.

- ① When the switch is turned ON, the "IN OPERATION" lamp is lit, and the conveyor is set in operation.
- ② When the conveyor brings a bottle case to a particular position, the sensor senses it.
- ③ When the bottle case is sensed, the stopper operates to stop it.
- ④ The lifter goes up, the arm moves forward, and the lifter goes down to put bottles in the case.
- ⑤ One is added to the value in the product counter.
- ⑥ When the CPU module concludes that the above procedure is completed, the stopper goes down to let the cases flow.

Repeat procedures ② to ⑥.

Introduction of related manuals

This Quick start guide explains the basic procedures for introducing programmable controllers. Read the following manuals to use each module with a full understanding according to your purpose.

■ Learning about programmable controllers

- QCPU User's Manual (Hardware Design, Maintenance and Inspection) . . . SH-080483ENG
This manual explains specifications, settings, and maintenance methods for the CPU module, the power supply module, and the base unit.
- Qn(H)/QnPH/QnPRHCPU User's Manual (Function Explanation, Program Fundamentals)
..... SH-080808ENG
- QnUCPU User's Manual (Function Explanation, Program Fundamentals) . . SH-080807ENG
This manual explains the functions of the CPU modules, and about devices and parameters that are the basic knowledge necessary for programming.
- I/O Module Type Building Block User's Manual SH-080042
This manual explains specifications and functions for the input module and the output module.

■ Learning about programming

- QCPU Programming Manual (Common Instructions) SH-080809
- QnACPU Programming Manual (Common Instructions) SH-080810
This manual explains the instructions used in programming.

■ Learning about programming tools (software)

- GX Developer Version 8 Operating Manual (Startup) SH-080372E
This manual explains the installation method for GX Developer Version 8.
- GX Developer Version 8 Operating Manual SH-080373E
This manual explains operation methods including program creation, parameter setting, writing/reading programs, and debugging.

Using programmable controllers

The programmable controllers are installed with procedures as shown below.

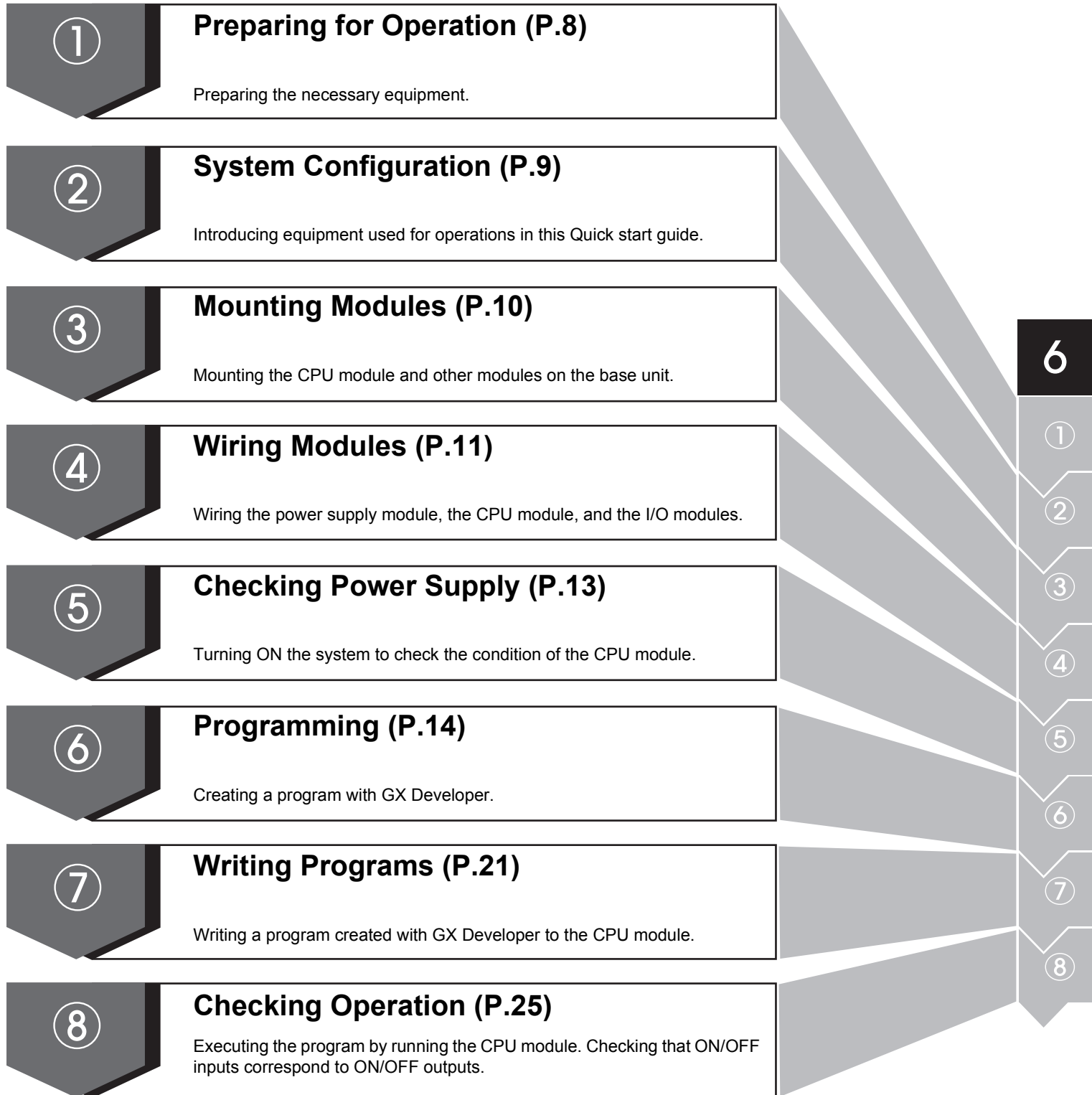

① Preparing for Operation

■ Preparing the necessary equipment

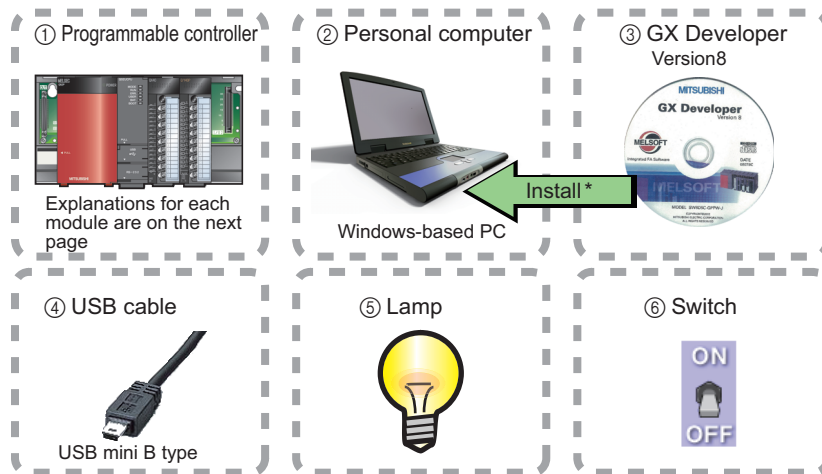

* GX Developer Version 8 needs to be installed in your personal computer in advance.

Reference

- GX Developer, the design and maintenance tool for Mitsubishi programmable controller, is necessary to set up programmable controllers and create sequence programs.
- For the installation and operation of GX Developer, refer to the following manuals.
 - ☞ GX Developer Version 8 Operating Manual (Startup): SH-080372E
 - ☞ GX Developer Version 8 Operating Manual: SH-080373E
- Compatible GX Developer version
The CPU module used and its functions differ in each version of GX Developer.
For the compatible GX Developer version, refer to the following manual.
 - ☞ QCPU User's Manual (Hardware Design, Maintenance and Inspection): SH-080483ENG

② System Configuration

■ System configuration example

This Quick start guide explains the following system configuration as an example.
Inputs and outputs are configured as switches and lamps respectively.

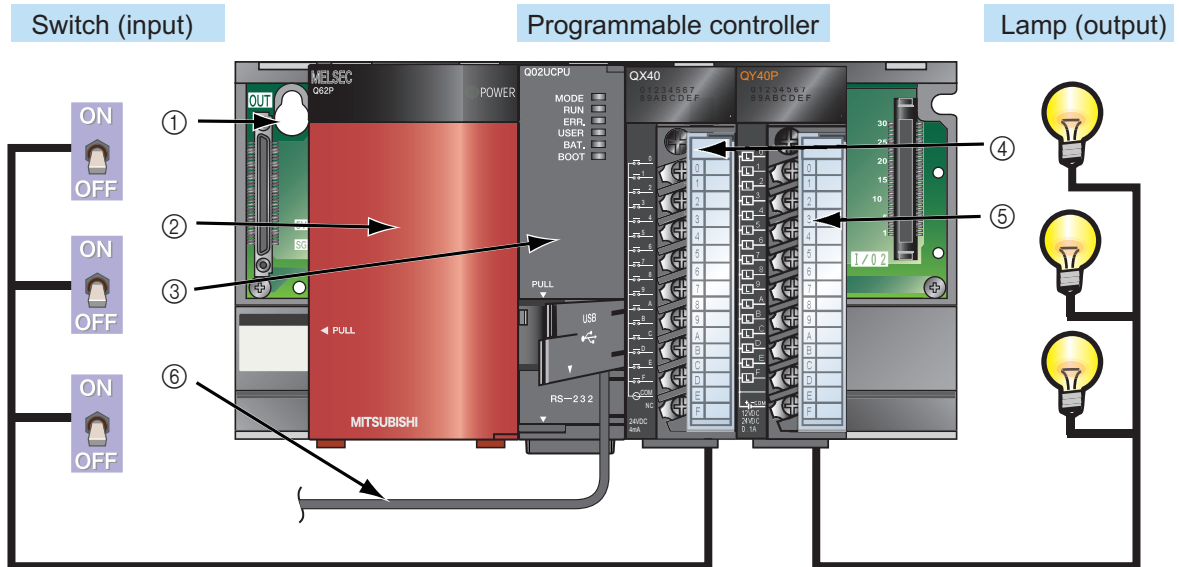

* Wires to the power supply module and the power of the I/O modules are omitted.

No.	Name	Model
①	Base unit	Q33B
②	Power supply module	Q62P
③	CPU module	Q02UCPU
④	Input module	QX40
⑤	Output module	QY40P
⑥	Connection cable (USB cable)	MR-J3USBCBL3M (USB A type - USB mini B type)

③ Mounting Modules

Mount prepared modules on the base unit.

A battery connector must be installed when using the CPU module for the first time.

⚠ Caution

The power supply must be disconnected when mounting modules.

■ Mounting modules

① Insert a module fixing projection into a module fixing hole on the base unit.



② Push the module in the direction of arrow until it clicks.



Complete

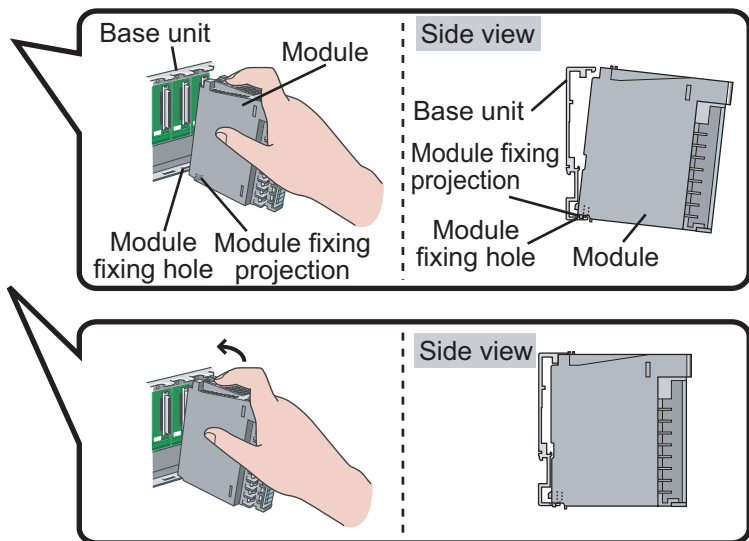

6

3

Point

● Installing a battery in the CPU module

① Open the cover at the bottom of the CPU module.



② Insert the connector of battery into the connector of CPU module.



③ Close the cover at the bottom of the CPU module.



Complete

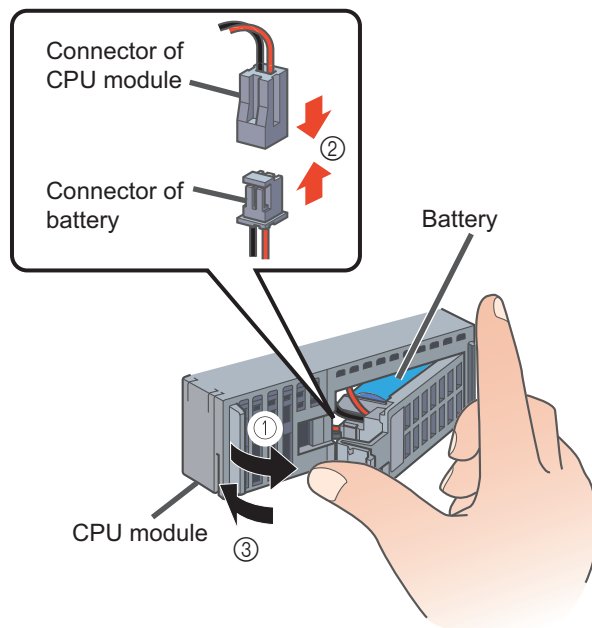

④ Wiring Modules

Wire the power supply module, the input module, and the output module.

⚠ Caution

The power supply must be disconnected when wiring modules.

📖 Reference

For details of wiring precautions, refer to the following manual.

👉 QCPU User's Manual (Hardware Design, Maintenance and Inspection):
SH-080483ENG

■ Wiring the power supply module

The following shows an example of wiring the power line and the ground wire to the base unit.

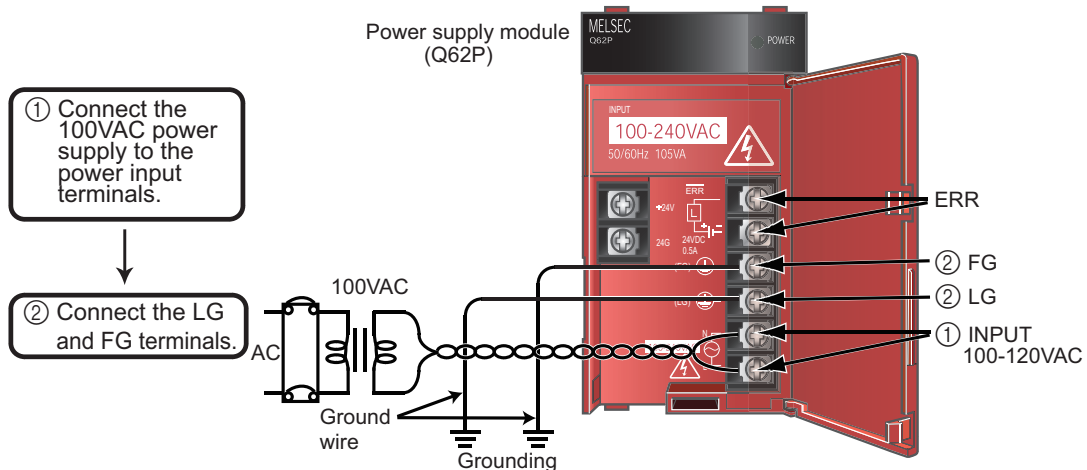

■ Wiring the input module

The following shows an example of wiring the input module (QX40).

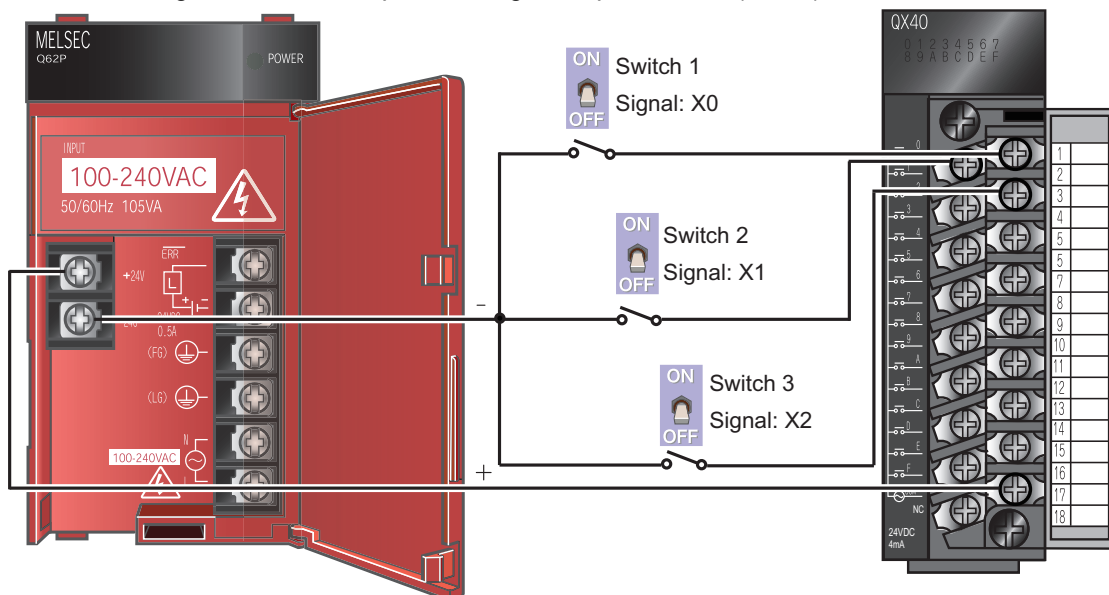

■ Wiring the output module

The following shows an example of wiring the output module (QY40P).

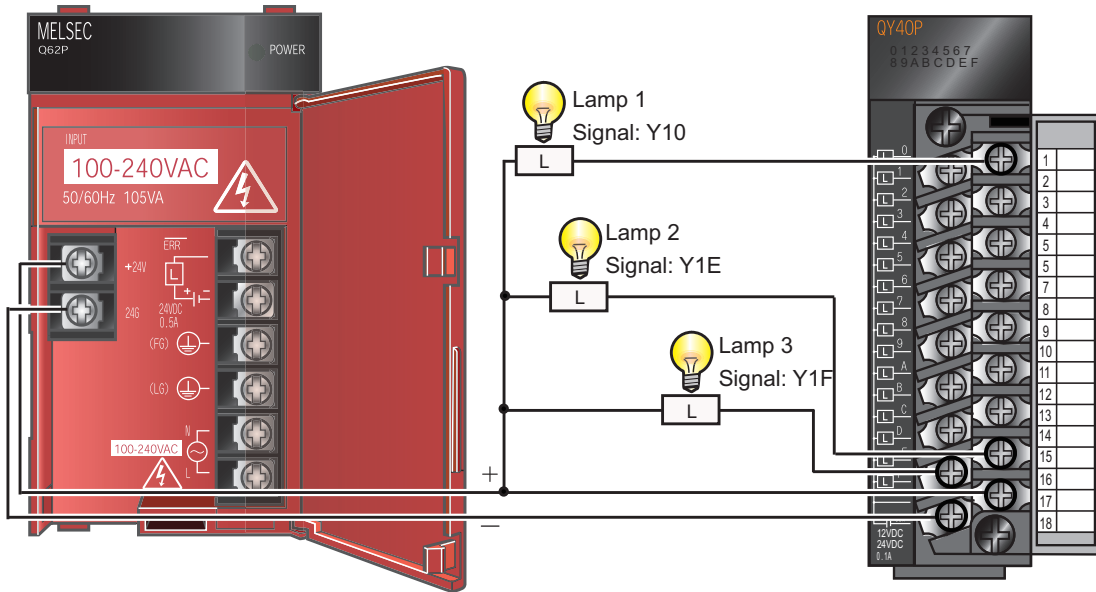

6



Wire the power supply lines separately for the I/O equipment and the programmable controller as shown below.

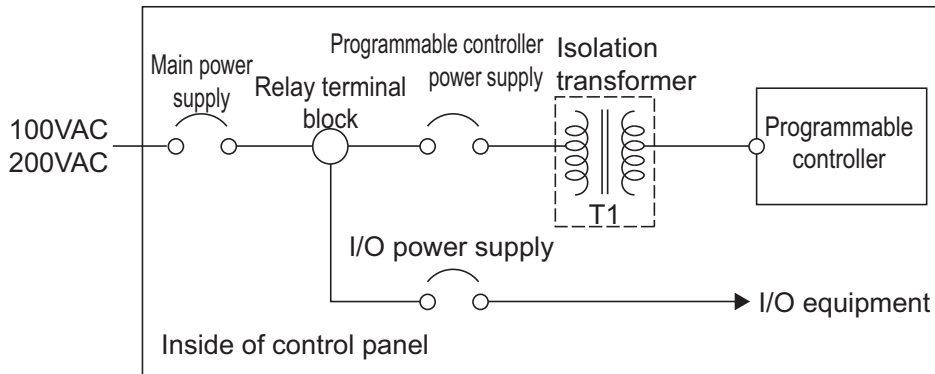

4

⑤ Checking Power Supply

Check that the power supply runs normally after configuring the system, mounting modules, and wiring.

Operating procedure

1. Check before turning ON the power supply.

- Wiring of the power supply
- Power supply voltage

2. Set the CPU module to STOP.

Set the switch on the front of the CPU module to STOP.

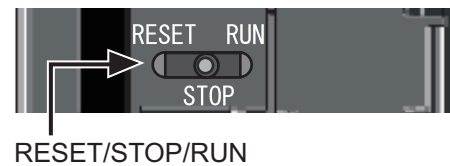

3. Supply power.

4. Check that the power supply runs normally.

Check the front LEDs on each module.

The following shows the normal state of the LEDs.

- ① Power supply module: "POWER" LED lights in green.
- ② CPU module: "MODE" LED lights in green.

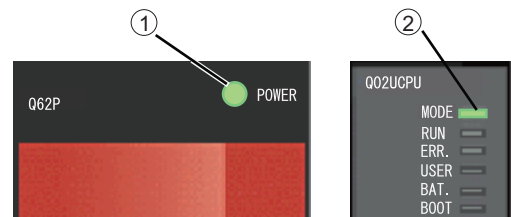

**Construction of the system is complete.
Turn OFF the power supply.**



● Troubleshooting

- ① When the "POWER" LED, "MODE" LED are OFF or flashing, refer to the following page.

☞ Troubleshooting (P.28)

- ② When a parameter or program is not written to the CPU module, the "ERR." LED flashes red, but it is not a problem at this stage.

"ERR." LED
flashes red.



⑥ Programming

Create a program (sequence program) for sequence control.

■ "Devices" and "instruction symbols" in programming

Combine "devices" and "instruction symbols" to create a sequence program.

1. Devices

Devices include bit devices and word devices.

① Bit device: handles one-bit information such as ON/OFF of a switch or a lamp.

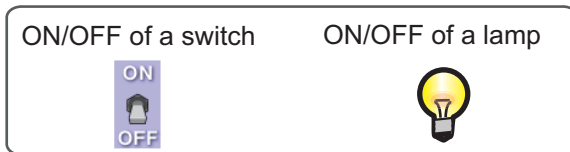

Examples of bit device

Device name	Device symbol	Description
Input	X	Receives a signal from an external device such as a switch.
Output	Y	Outputs a signal to an external device such as a lamp
Internal relay	M	Temporarily saves data status in programs.
Timer (contact)	T	Used to measure time (when the set time comes, the contact is set to ON).
Counter (contact)	C	Used to count the number of times the input condition turns from OFF to ON (when the counter reaches the set number, the contact is set to ON).

② Word device: handles 16-bit information such as numeric values and character strings.

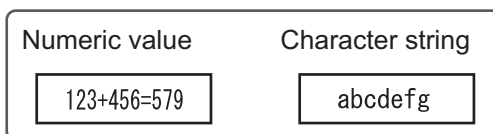



Examples of word device

Device name	Device symbol	Description
Data register	D	Registers numeric values and character strings.
Timer (current value)	T	Used to measure time (stores the current value of measuring time).
Counter (current value)	C	Used to count the number of times the input condition turns from OFF to ON (stores the current value of the counter).

2. Instruction symbols

The following shows the basic instructions of sequence control.

Instruction symbol	Description
	Open contact: Conducts when an input signal is set to ON.
	Closed contact: Conducts when an input signal is set to OFF.
	Coil output: Outputs data to a specified device.

Reference

This section explains the most basic devices and instructions.

In addition to those listed above, other devices and instructions convenient for sequence control are available.

 QCPU Programming Manual (Common Instructions): SH-080809



 QnACPU Programming Manual (Common Instructions): SH-080810

Creating a program

Create a sequence program.

The following shows how to create a sequence program with basic devices and instruction symbols for sequence control.

The following devices and instruction symbols are used.

- Input: X device
- Output: Y device
- Instruction symbols:  ,  , 

Create a program that performs the following controls.

- When the X0 and X1 switches are turned ON, the Y10 output lamp turns ON.
- When the X2 switch is turned ON, the Y1E and Y1F output lamps turn OFF.

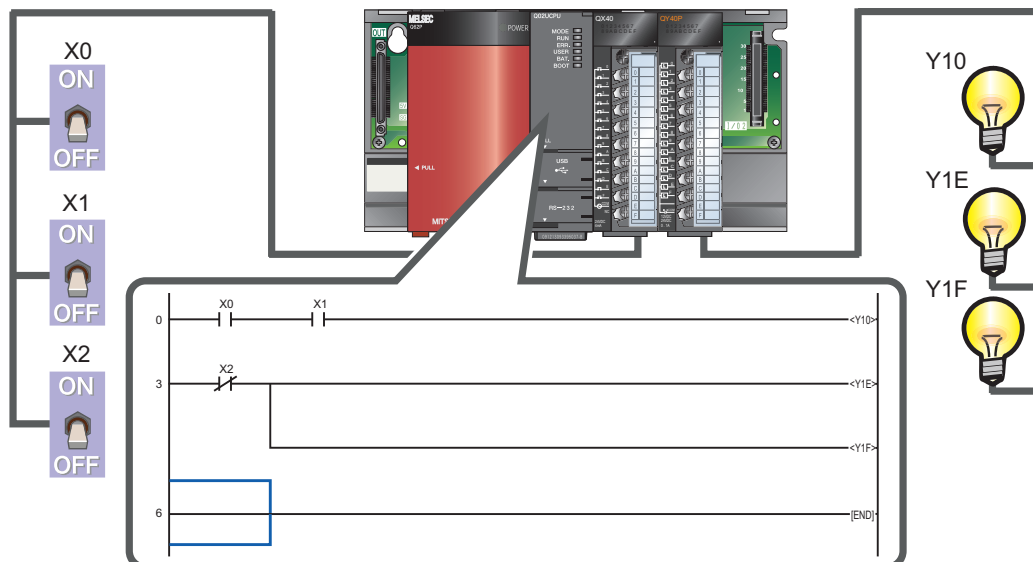

The following explains the procedure to create this sequence program.

Starting GX Developer

Operating procedure

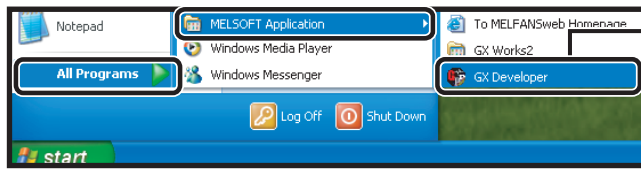

Select [Start] → [All Programs]
→ [MELSOFT Application]
→ [GX Developer].



After starting, the GX Developer main screen is displayed.

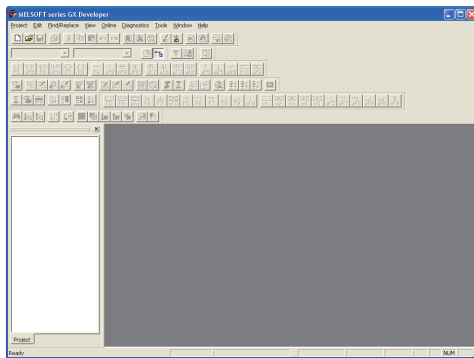

Creating a new project

Operating procedure

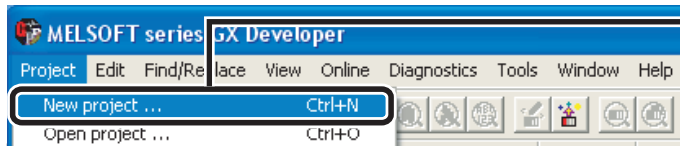

① Select [Project] →
[New project]
(**Ctrl** key + **N** key) ().

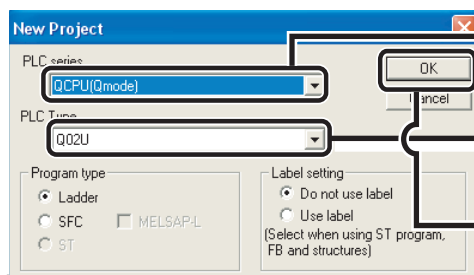

② Select QCPU (Q mode).
③ Select the QCPU to be used
(Q02UCPU in this manual).
④ Click the **OK** button.

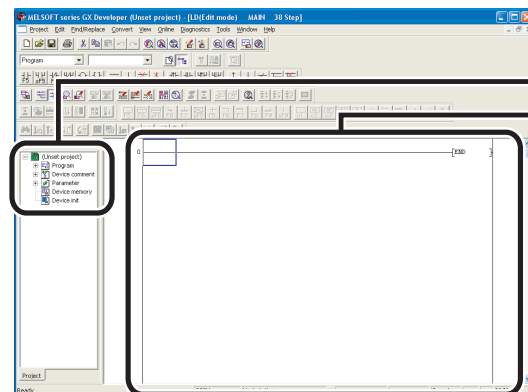

A project tree is displayed.
A ladder screen is displayed.

■ Entering a sequence program

Operating procedure

1. Enter $\begin{matrix} X0 \\ | \\ \text{---} \\ | \\ \text{---} \end{matrix}$.

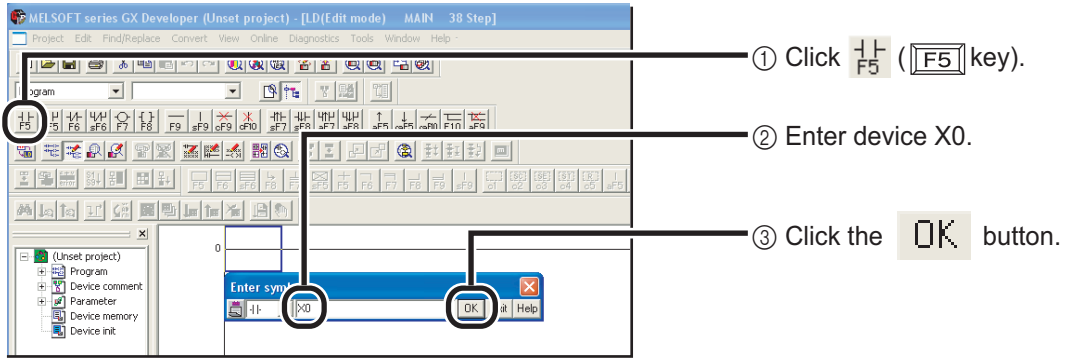

2. Enter $\begin{matrix} X1 \\ | \\ \text{---} \\ | \\ \text{---} \end{matrix}$.

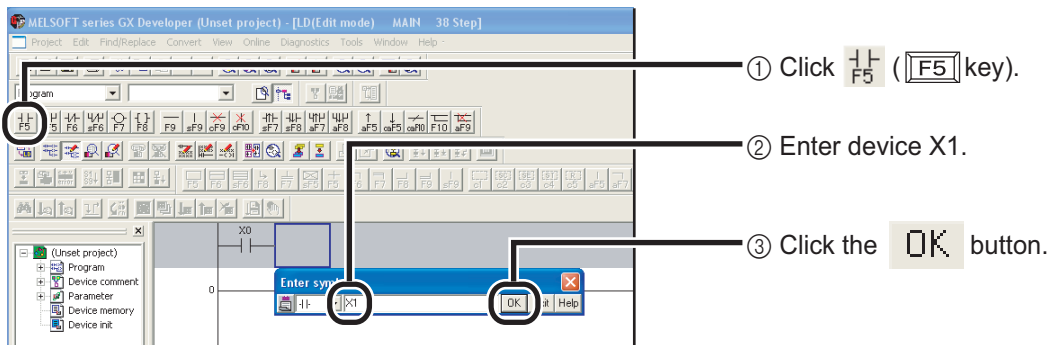

3. Enter $\langle Y10 \rangle$.

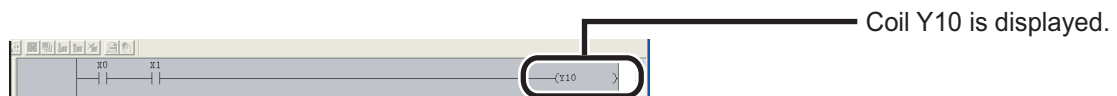
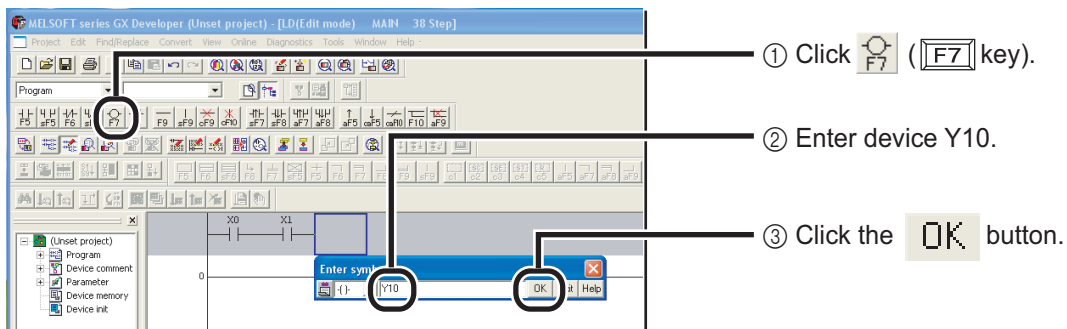

4. Enter $X2$.

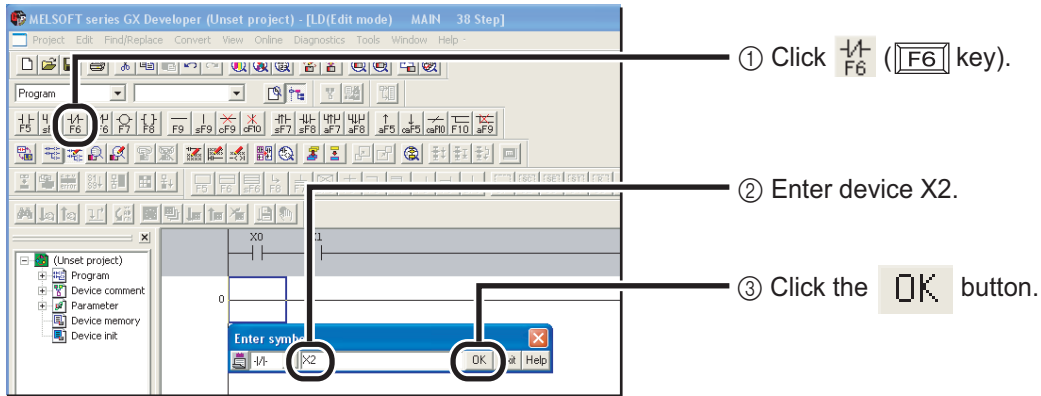

5. Enter $(Y1E)$.

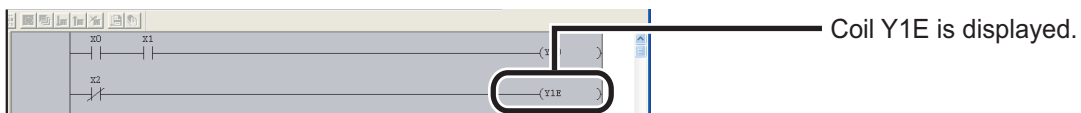
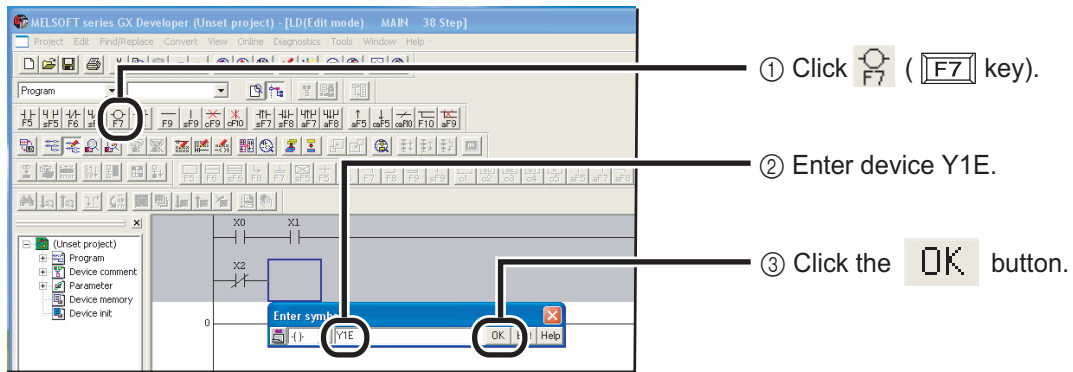

6. Draw a line.

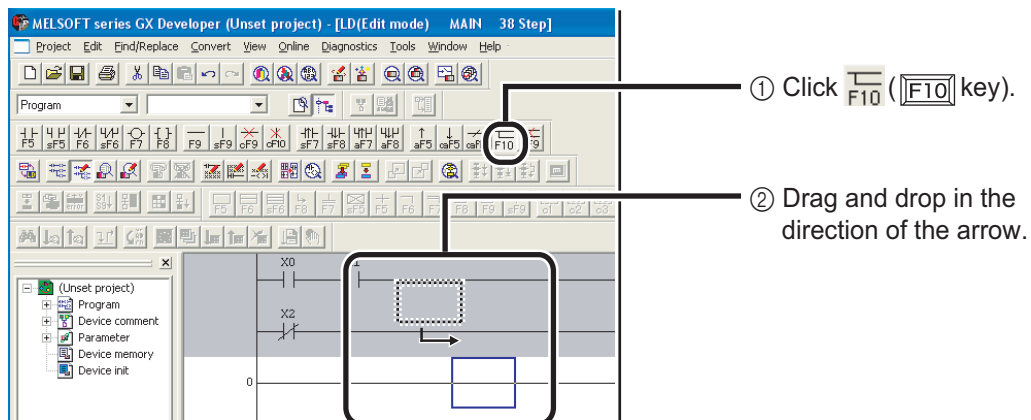

7. Enter (Y1F).

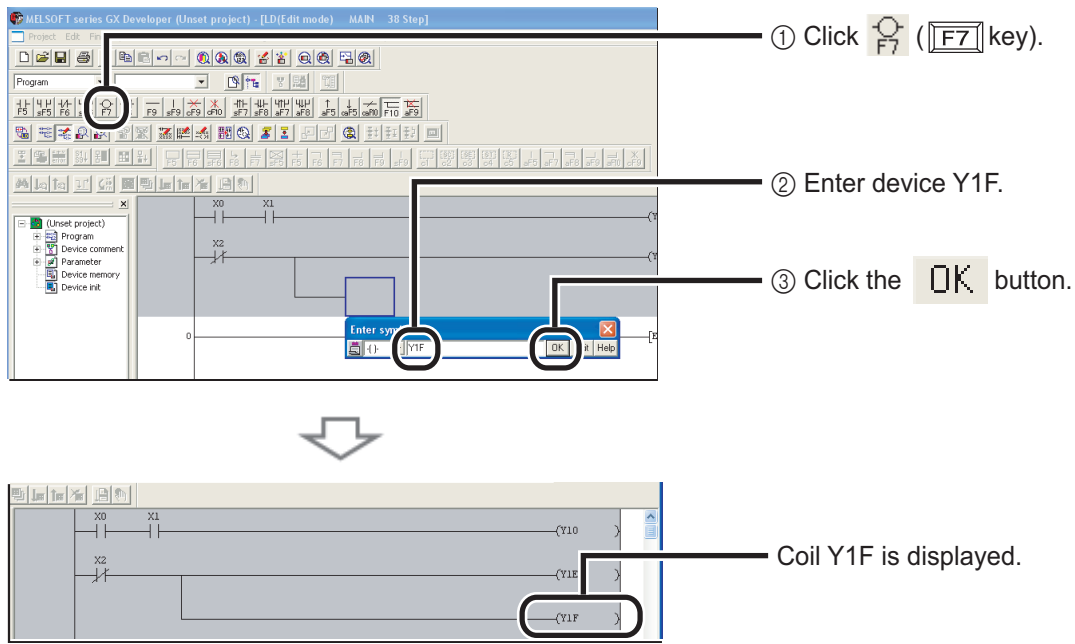

■ Converting a program

Define the contents of the entered ladder block.

Operating procedure

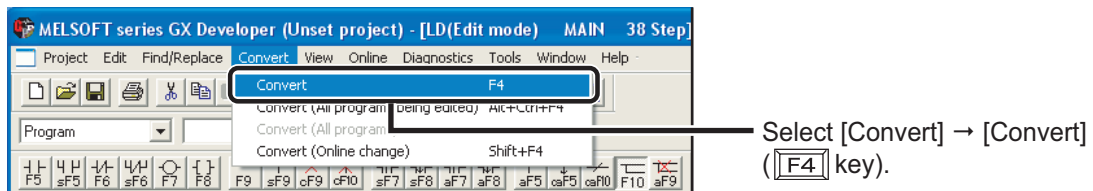

Perform the conversion to align entered ladders. When completed, the gray display turns to white.
[Before conversion]



[After conversion]

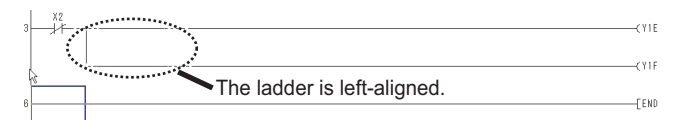

The programming is completed.

■ Saving a project

A program is saved in unit of project.

Save the created project with a name.

Operating procedure

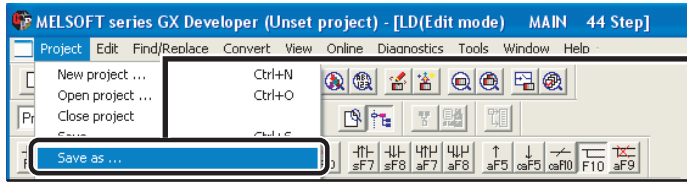

① Select [Project] → [Save as] ().



The "Save the project with a new name" screen is displayed.

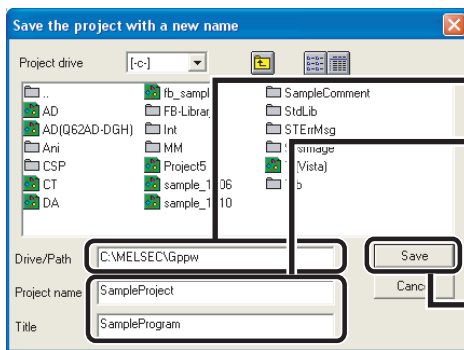

② Specify the save location.

③ Enter the name and title of the project.

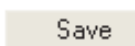
④ Click the  button.

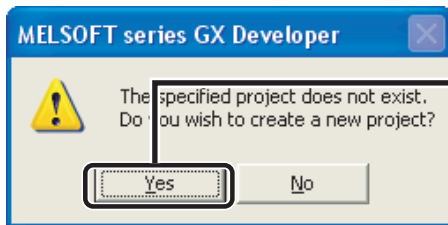

⑤ Click the  button.

The project is saved.

6

6

⑦ Writing Programs

Write the program to the CPU module.

■ Connecting the CPU module and the personal computer

Connect the CPU module and the USB port of the personal computer with a USB cable.

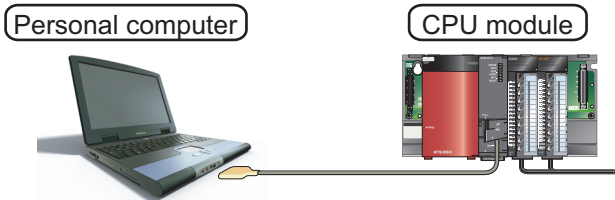

■ Turning ON the programmable controllers

Turn ON the power supply module, the input module, and the output module.

■ Setting GX Developer and the programmable controller connection

Operating procedure

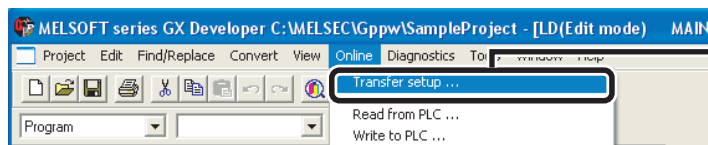

① Select [Online] → [Transfer setup].



The "Transfer Setup" screen is displayed.

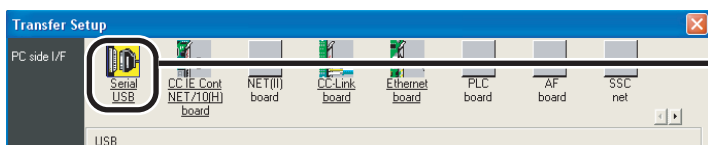
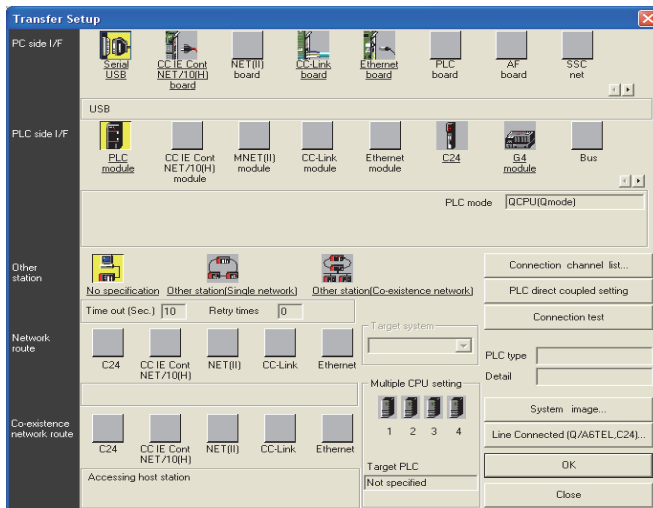

② Double-click "Serial USB".



To the next page

The "PC side I/F Serial setting" screen is displayed.

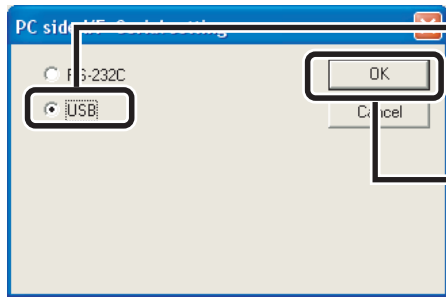

③ Select "USB".

④ Click the **OK** button.

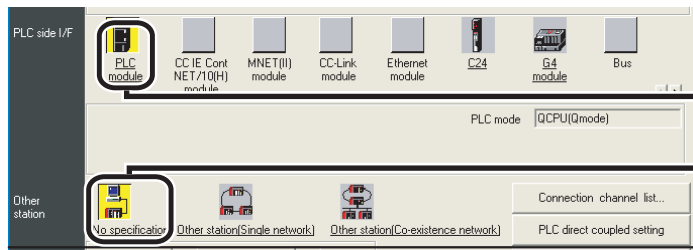

⑤ Click "PLC module".

⑥ Click "No specification".

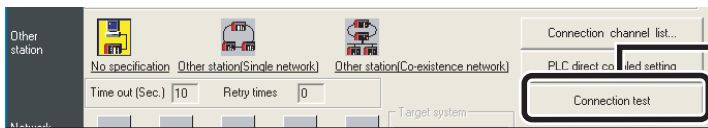

⑦ Click the **Connection test** button.

When properly connected, the connection completion message is displayed.

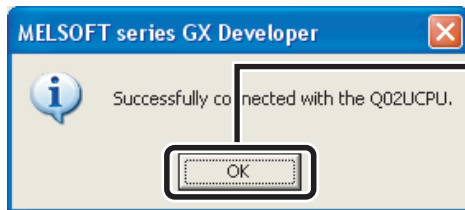

⑧ Click the **OK** button.

* When the screen on the right is displayed, check the system and the settings.

☞ Troubleshooting (P.28)

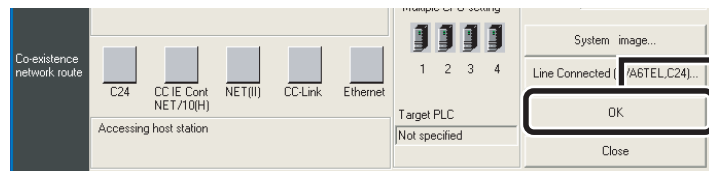
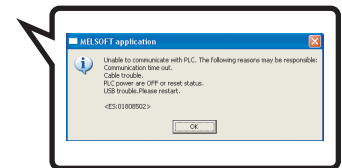

⑨ Click the **OK** button.

The connection setting is completed.

■ Formatting the CPU module

Before writing the program, format the CPU module to set it to the initial status.

Operating procedure

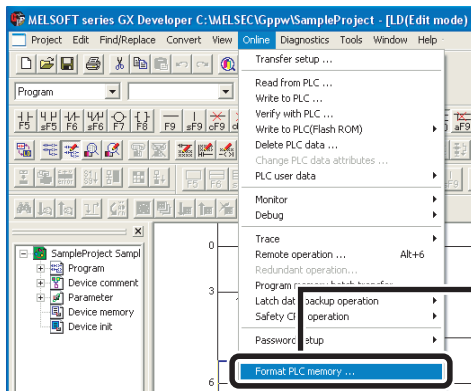

① Select [Online] → [Format PLC memory].

The "Format PLC memory" screen is displayed.

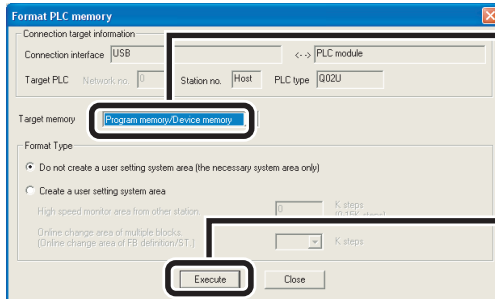

② Select "Program memory/Device memory" from "Target memory".

③ Click the Execute button.

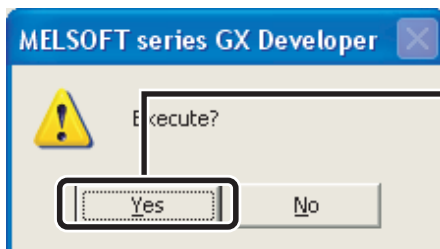

④ Click the Yes button.

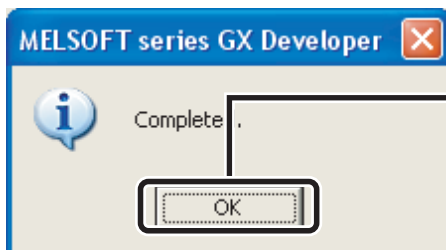

⑤ Click the OK button.

The CPU module format is completed.

Click the Close button to close the "Format PLC memory" screen.



When data such as programs and parameters are already stored in the CPU module, they are deleted. Thus the necessary data should be read from the programmable controller CPU and saved as a project before executing the Format PLC memory function.

■ Writing programs to the CPU module

Operating procedure



- ① Select [Online]
→ [Write to PLC] ().



The "Write to PLC" screen is displayed.

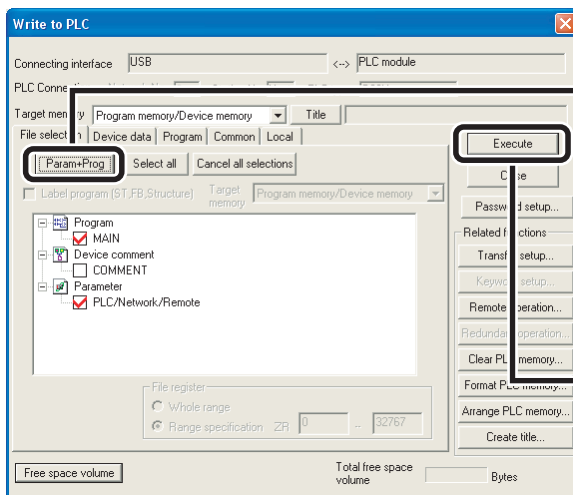

- ② Click "Param+Prog".
↓
- ③ "Program" and "Parameter" are checked.
- ④ Click the **Execute** button.



When the Write to PLC function is properly executed, the following message is displayed.

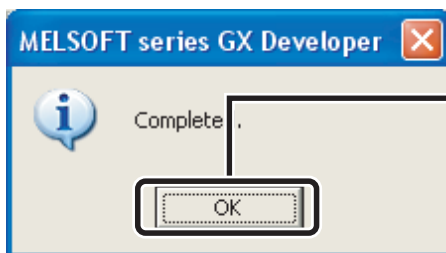

- ⑤ Click the **OK** button.

The program writing is completed.

Click  to close the "Write to PLC" screen.

6

7



● PLC parameter

The PLC parameter is necessary to start the CPU module. The default values are used in this system configuration.

For details of setting parameters, refer to the following manuals.

 Qn(H)/QnPH/QnPRHCPU User's Manual (Function Explanation, Program Fundamentals): SH-080808ENG

 QnUCPU User's Manual (Function Explanation, Program Fundamentals): SH-080807ENG

⑧ Checking Operation

Execute the program written to the CPU module to check the operation.

Check the program operation with the switches and lamps or the monitor function of GX Developer.

■ Executing the program written to the programmable controller CPU

Use the "RESET/STOP/RUN" switch on the front of the CPU module for the operation.

The usage of the RESET/STOP/RUN switch

- RUN : Executes the sequence program operation.
- STOP : Stops the sequence program operation.
- RESET: Performs the hardware reset, operation error reset, and operation initialization.

Operating procedure

1. Resetting the CPU module

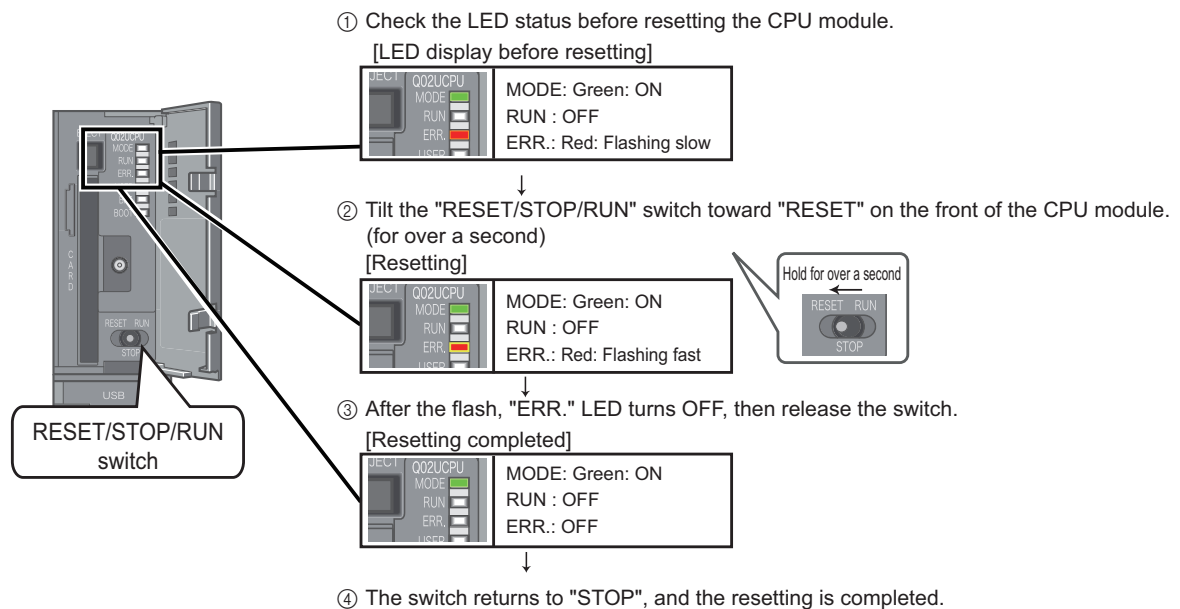

Reference

When the flashing "ERR." LED does not turn OFF, refer to the following page.

☞ Troubleshooting (P.28)

2. Executing the program

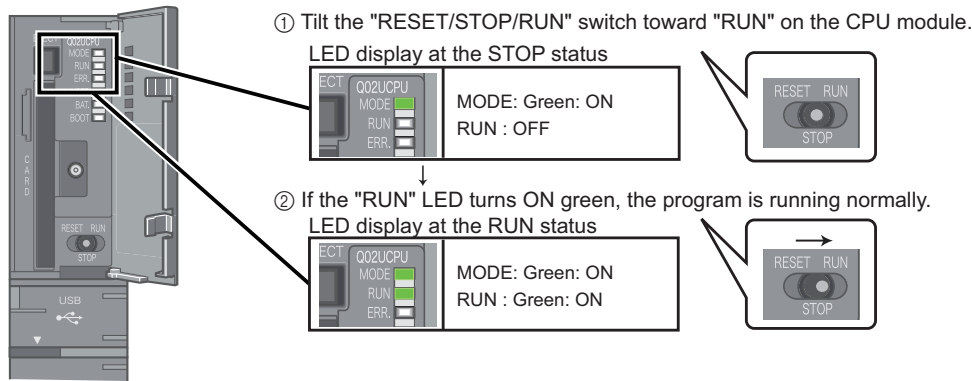

Caution

Do not use pointed tools such as a screwdriver when operating the switch.
They may damage the switch.

6

Using switches and lamps to check the operation

Check the program operation by turning the switches and lamps ON/OFF.

If all of the switches (X0, X1, X2) are OFF right after the execution of the program, the output lamp Y10 stays OFF and the output lamp Y1E and the output lamp Y1F stay ON due to the instructions from the created program.

1. Operation check 1

Turn ON the switch X0. → The output lamp Y10 stays OFF and the output lamp Y1E and Y1F stay ON.

2. Operation check 2

Turn ON the switch X1. → The output lamp Y10 turns ON.

3. Operation check 3

Turn ON the switch X2. → The output lamp Y1E and Y1F turn OFF.

Checking the operation in GX Developer

Check the program operation by using the monitor mode on the GX Developer screen, where the status of switches and lamps can be operated and checked.

Operating procedure

1. Set the operating program display screen to the monitor mode.

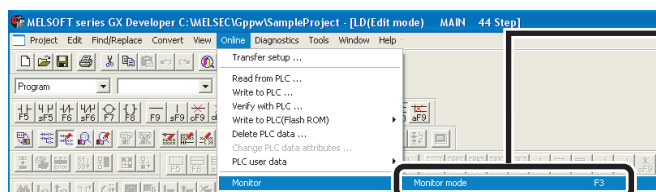

Select [Online] → [Monitor]
→ [Monitor mode] ([F3] key)
()

To the next page

8



Execute the monitor to display the "Monitor status" screen.

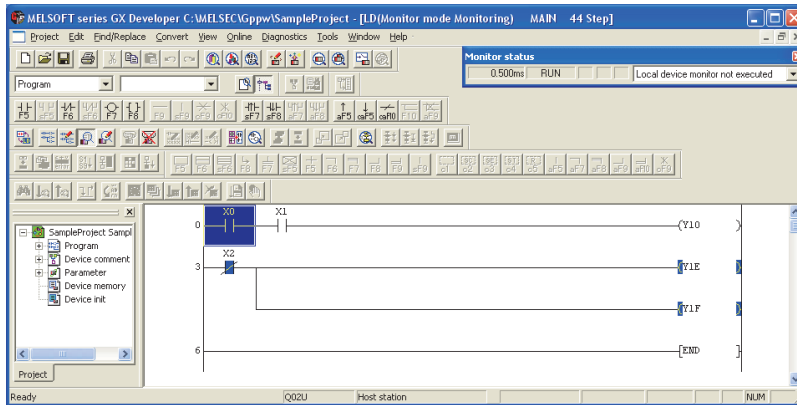

The ON/OFF status of bit devices can be checked on the ladder screen.

Contacts/outputs set to ON are displayed in blue.

Right after the program execution, bit devices X02, Y1E, and Y1F are lit blue due to the instructions from the program.

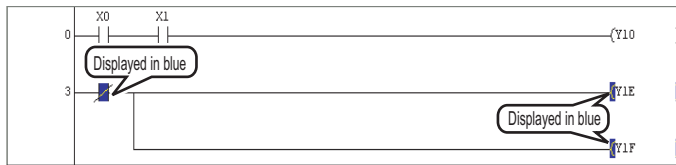

2. Operation check 1

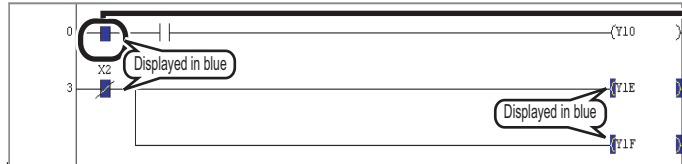

① Double-click X0 while pressing the **Shift** key → X0 turns ON.

3. Operation check 2

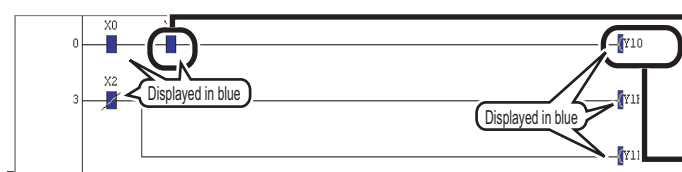

② Double-click X1 while pressing the **Shift** key → X1 turns ON.

↓
Y10 turns ON.

4. Operation check 3

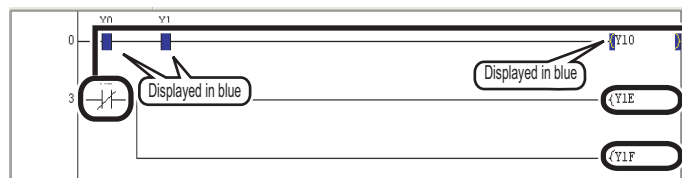

③ Double-click X2 while pressing the **Shift** key → X2 turns ON.

↓
Y1E and Y1F turn OFF.



While pressing the **Shift** key, double-click devices set to ON in Operation checks 1 and 2 to turn them OFF.

Troubleshooting





When modules do not run normally, refer to the following troubleshooting information.

■ Programmable controller troubleshooting

1. First, check the following points.

- 1) The ON/OFF status of the power supply
- 2) The mounting condition of the power supply module, the CPU module, and the I/O modules
- 3) The LED on the front of the CPU module

2. Check the problem and respond according to the following list.

Problem	Check	Action
The "POWER" LED is OFF after turning ON the power supply module.	Is the power supply module properly wired and mounted?	Wire and mount the module properly.  ③ Mounting Modules (P.10)  ④ Wiring Modules (P.11)
The "ERR." LED on the CPU module is flashing red.	Are programs and PLC parameters written to the CPU module?	Write programs and parameters to the CPU module.  ⑦ Writing Programs (P.21)
	If the CPU has several programs, are they registered to the PLC parameter?	If there are several programs, register them in the program setting of the PLC parameter, and write the parameters to the CPU module. If several programs are not needed, delete unnecessary data, or execute the Format PLC memory function before writing data to the programmable controller CPU.  GX Developer Version 8 Operating Manual: SH-080373E
	Other than above	Handle by checking for errors following "Checking errors in the CPU module" (P.30) in this manual.
The "BAT" LED on the CPU module is ON or flashing.	Is the battery properly connected?	Properly connect the battery.  ③ Mounting Modules (P.10)







Reference

For details of the troubleshooting, refer to the following manual.

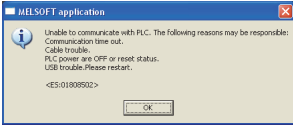
 QCPU User's Manual (Hardware Design, Maintenance and Inspection):
SH-080483ENG

■ Troubleshooting when using GX Developer

Check the problem and respond according to the following list.

Problem	Check	Action
<p>The CPU module cannot communicate with the personal computer (GX Developer).</p>  <p>(Communication error message)</p>	Is the correct cable used?	<p>Check the cables.</p> <p> GX Developer Version 8 Operating Manual: SH-080373E</p>
	Is the GX Developer transfer setup properly set?	<p>Check the transfer setup.</p> <p>  Writing Programs (P.21)</p>
	Is the USB driver properly installed?	<p>Properly install the USB driver, referring the following manual.</p> <p> GX Developer Version 8 Operating Manual (Startup): SH-080372E</p>
Programs cannot be written.	Has a write protect password been set in GX Developer?	<p>Unlock the password.</p> <p> GX Developer Version 8 Operating Manual: SH-080373E</p>

■ Checking errors in the CPU module

If a problem occurs, errors can be checked by diagnosing the programmable controller CPU in GX Developer.

Operating procedure



① Select [Diagnostics] → [PLC diagnostics].

PLC Diagnostics screen (example)

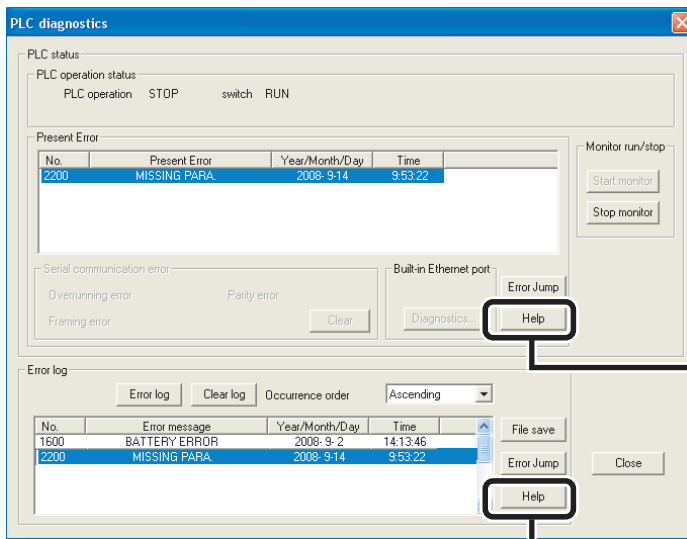

(Present Error)

② Click the Help button.

(Error log)

② Click the Help button.

Help screen (example)

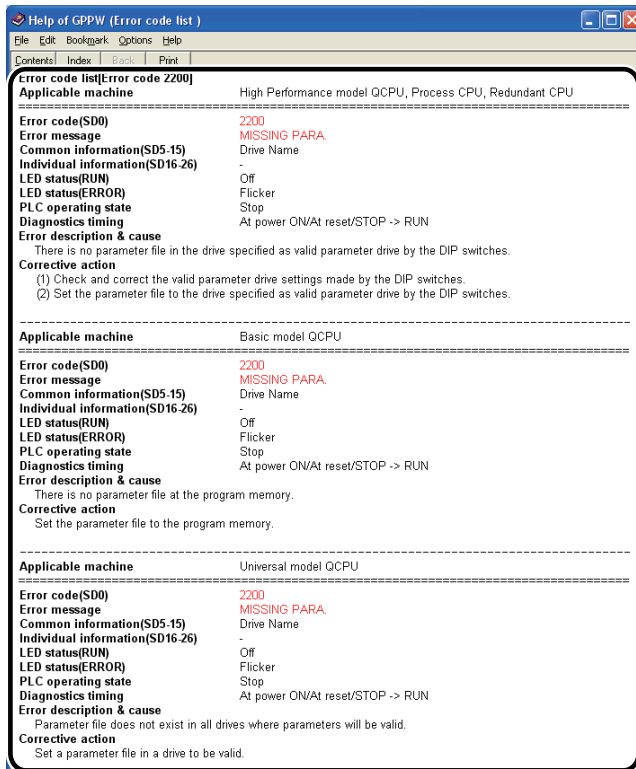

Current errors and corrective actions are displayed.

Frequently-used functions

This section explains functions frequently used in GX Developer.

■ Clarifying programs <Comment> (P.32)

Device comment

Statement

Note

■ Monitoring device values and status <Device monitor> (P.37)

Device batch monitor

Entry data monitor

■ Changing device values <Device test> (P.41)

Bit device forced ON/OFF

Word device current value modification

■ Changing running programs <Online program change> (P.43)

■ Checking errors <Error jump> (P.44)

■ Monitoring system status <System monitor> (P.45)

■ Clarifying programs <Comment>

Use comments to clarify the contents of a program.

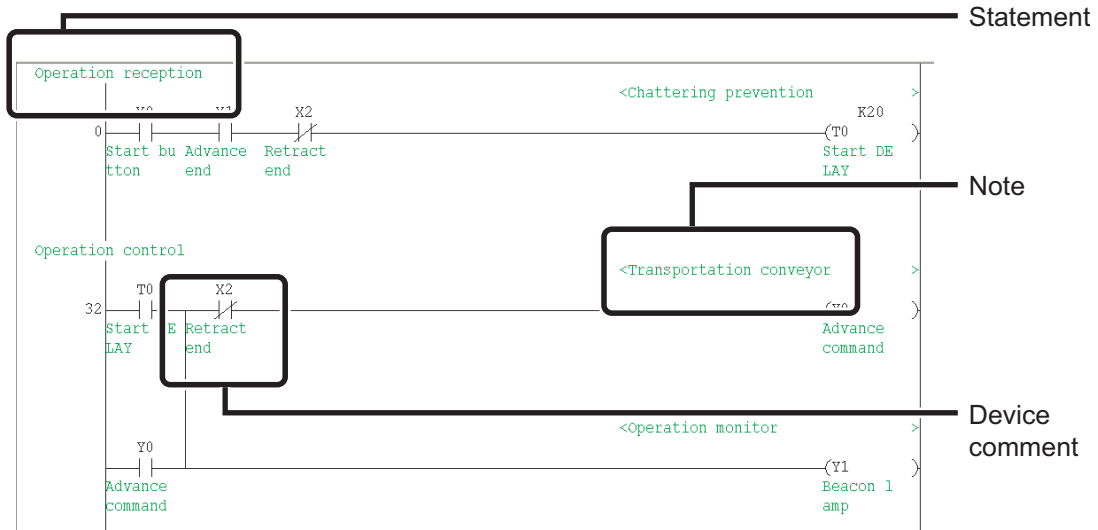

The followings are the three types of comment.

Type	Description	Number of characters
Device comment	Describes roles and usage of each device.	32
Statement	Describes roles and usage of ladder blocks.	64
Note	Describes roles and usage of output instructions.	32



Select [View] → [Comment] (key + key) to switch the comment display/hide setting.

● Creating device comments

Device comments can be entered from the list or on the ladder diagram.

<Input operation from the list>

Operating procedure

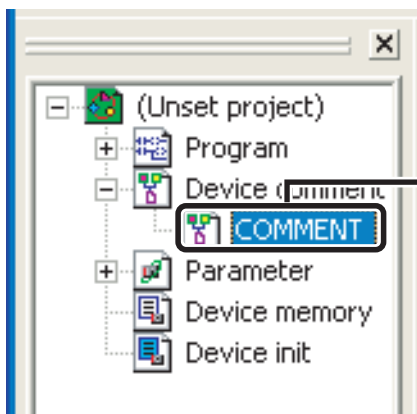

① Double-click [COMMENT] under [Device comment] in the project list.



To the next page

② Enter the start device number in "Device name".

③ Click the **Display** button.

④ Enter a comment in the "Comment" column.

⑤ When entering comments for other devices, enter a device number again as in the step ②.

⑥ Click **X** to close the screen.

<Input operation on the ladder diagram>

Operating procedure

① Select [Edit] → [Documentation] → [Comment] ().

② Double-click the ladder symbol to enter a comment.

③ Enter a comment on the "Enter device comment" screen.

④ Click the **OK** button.

⑤ Select the [Comment] menu in the step ① again to finish the operation.

● Entering comments when creating ladders

Operating procedure

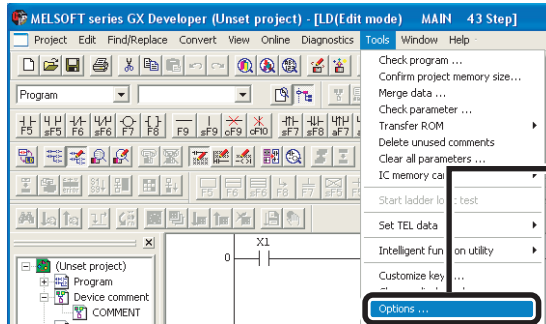

① Select [Tools] → [Options].

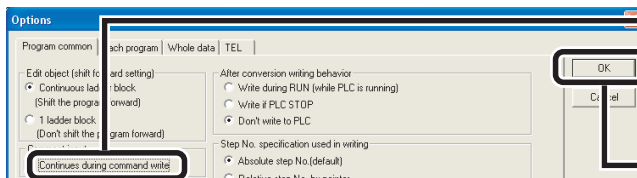

② Check "Continues during command write" of "Comment input" in the <Program common> tab.

③ Click the **OK** button.



After the ladder input operation, the "Enter device comment" screen is displayed to enter a comment.

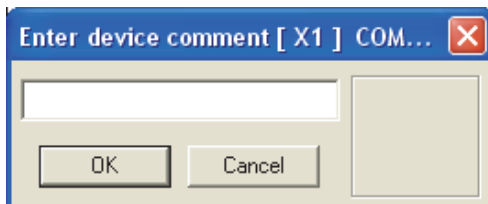

● Creating statements

Operating procedure

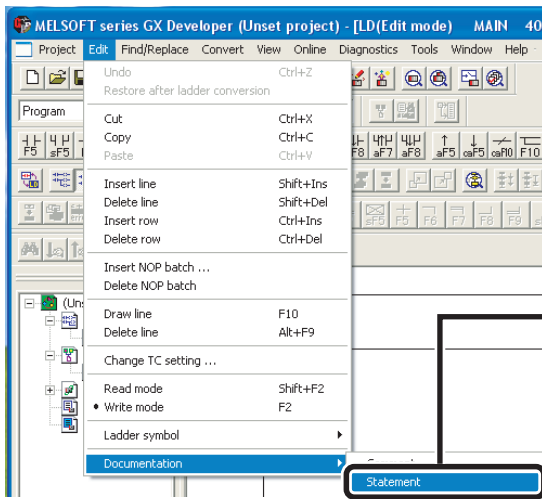

① Select [Edit] → [Documentation] → [Statement] ().

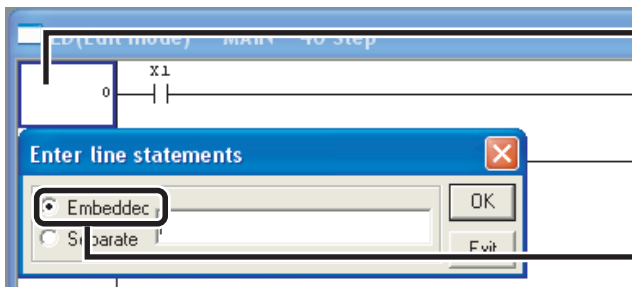

② Double-click a ladder block to enter a statement.

③ Select "Embedded".

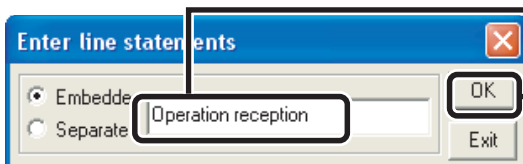

④ Enter a statement on the "Enter line statements" screen.

⑤ Click the  button.

⑥ Select the [Statement] menu in the step ① again to finish the operation.



If a statement is entered, a program needs to be "converted" to reflect the input. For details on the conversion, refer to the following page.

 ⑥ Programming - Converting a program (P.19)



The followings are the two types of statement.

- Integrated (Embedded) statement

Integrated statements can be written to/read from the CPU module.

- Peripheral (Separate) statement

The program memory capacity can be saved since peripheral statements are not written to the CPU module. "*" is prefixed to the peripheral statement in the program.

- Creating notes

Operating procedure

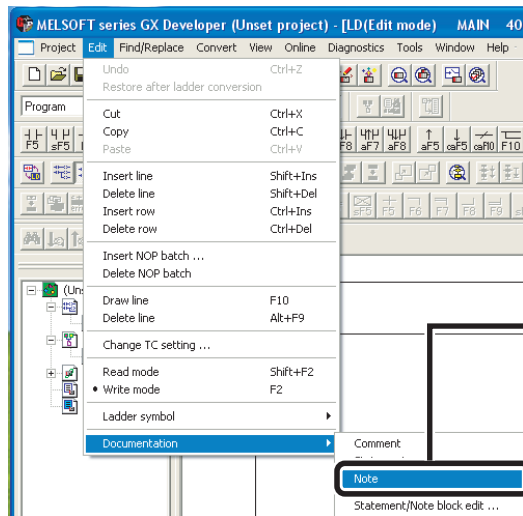

① Select [Edit] → [Documentation] → [Note] ().

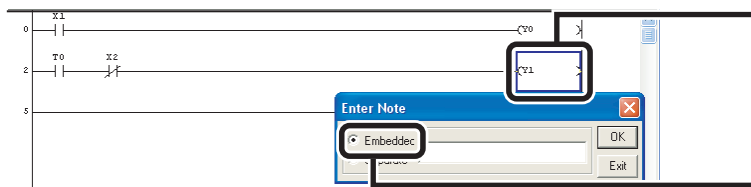

② Double-click the output instruction symbol to enter a note.

③ Select "Embedded".



④ Enter a note on the "Enter Note" screen.

⑤ Click the **OK** button.

⑥ Select the [Note] menu in the step ① again to finish the operation.

⑦ Click  to close the screen.



The followings are the two types of note.

- Integrated (Embedded) note

Integrated notes can be written to/read from the CPU module.

- Peripheral (Separate) note

The program memory capacity can be saved since peripheral notes are not written to the CPU module. "*" is prefixed to the peripheral note in the program.

■ Monitoring device values and status <Device monitor>

The followings are the two types of device monitor.

Type	Purpose
Device batch monitor	Used to monitor consecutive devices of one type.
Entry data monitor	Used to simultaneously monitor separately-located devices in the ladder or various devices on one screen.

● Device batch monitor

Monitors consecutive devices by specifying the start device number.

Operating procedure

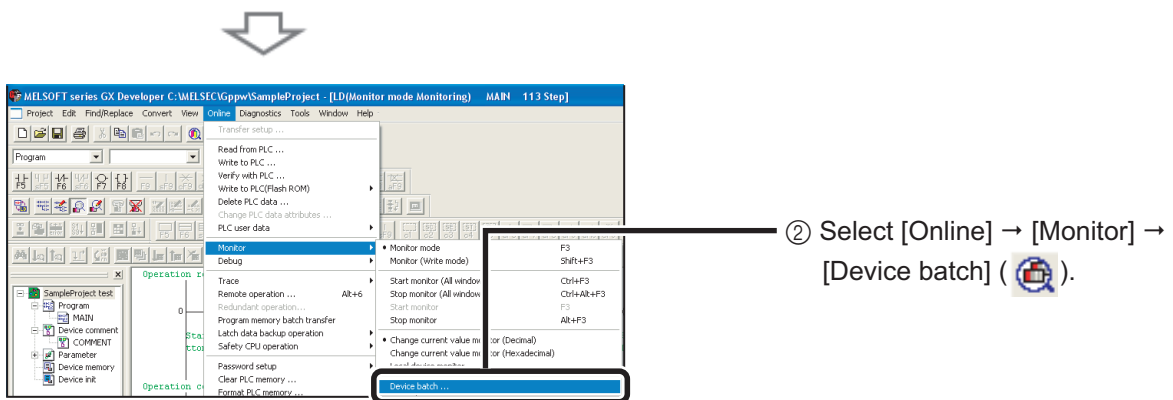
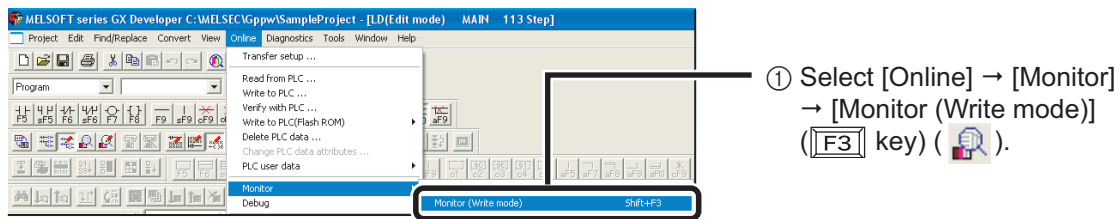

* The "Device batch monitor" screen can be displayed by selecting [Device batch] with a right click on the ladder screen.

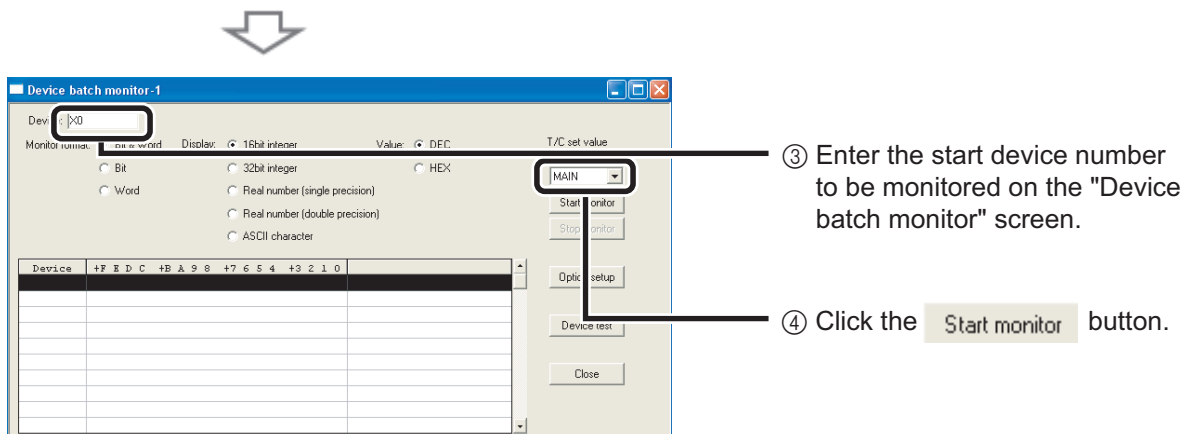

To the next page

The values of devices and the ON/OFF status of contacts/coils are displayed.

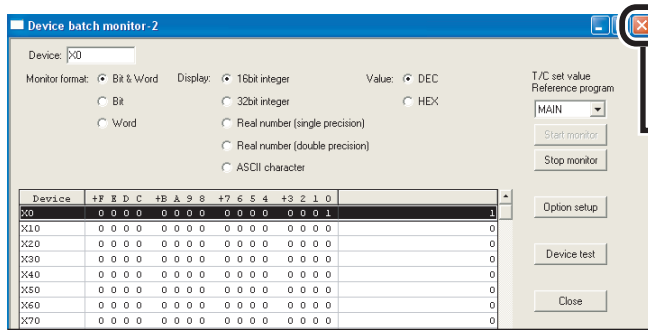

⑤ Click to close the screen.

● Entry data monitor

The device registration methods used to perform the Entry data monitoring are the specified device registration and the device registration with ladder monitor display.

<Specified device registration>

Register specified devices on the "Entry data monitor" screen.

Operating procedure

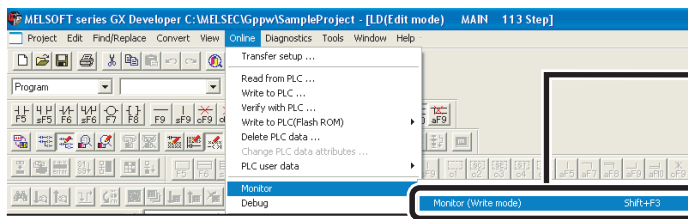

① Select [Online] → [Monitor] → [Monitor (Write mode)] (key) ().

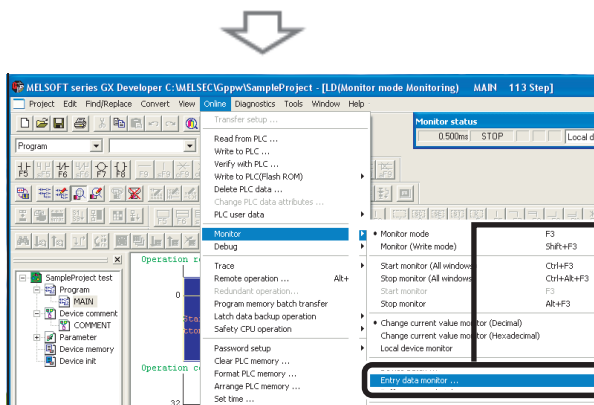

② Select [Online] → [Monitor] → [Entry data monitor] ().

* The "Entry data monitor" screen can be displayed by selecting [Entry data monitor] with a right click on the ladder screen.

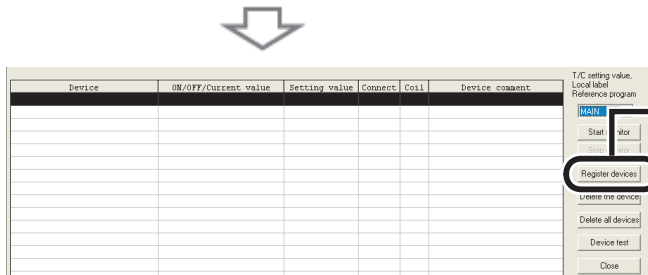

③ Click the button on the "Entry data monitor" screen.

To the next page

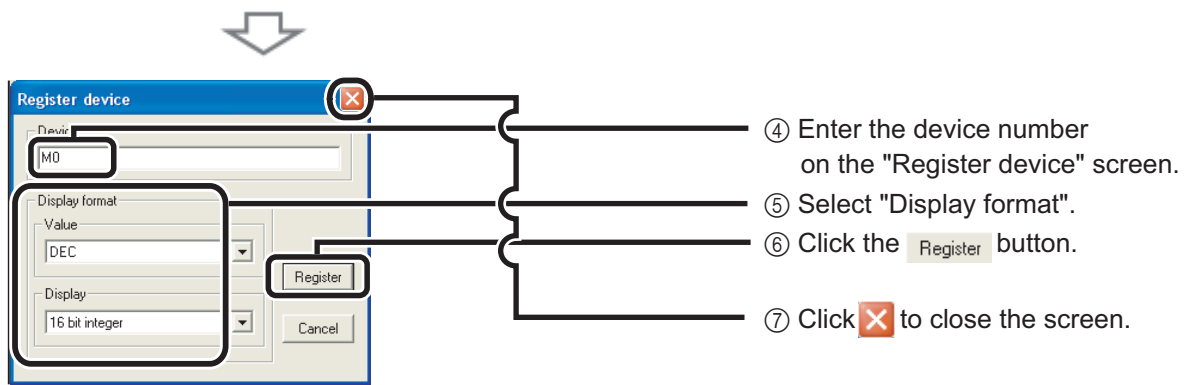

The specified device is registered on the "Entry data monitor" screen.

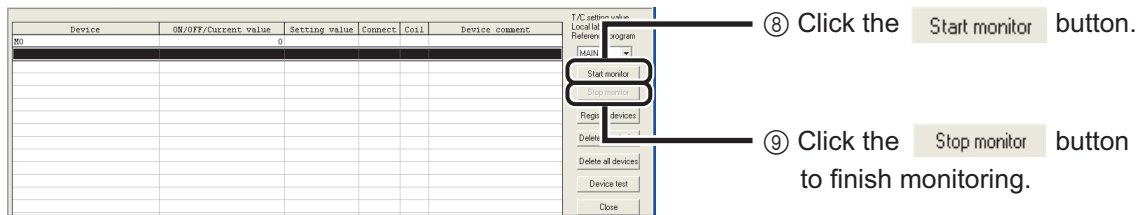

The values of devices and the ON/OFF status of contacts/coils are displayed.

<Device registration with ladder monitor display>

Specify the range of the ladder diagram in the ladder monitor screen and register the devices in a batch.

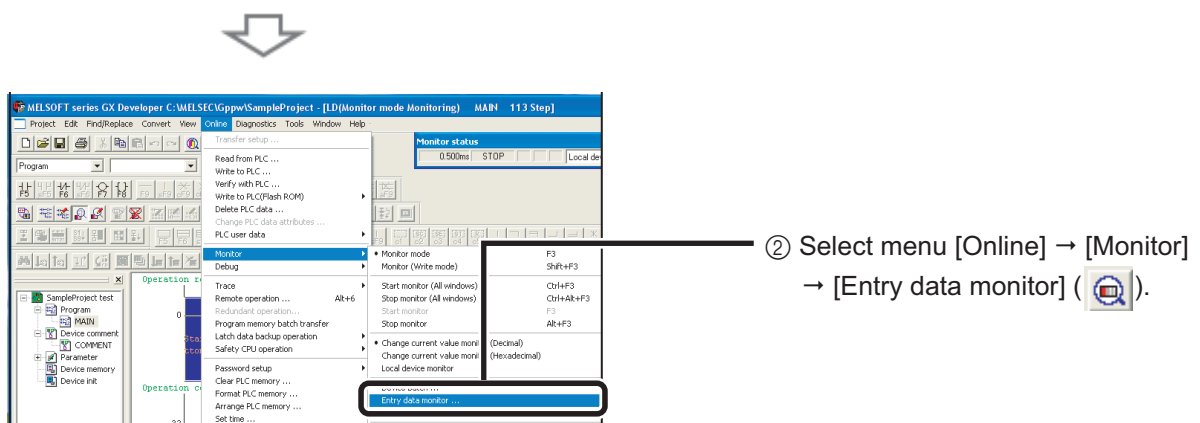
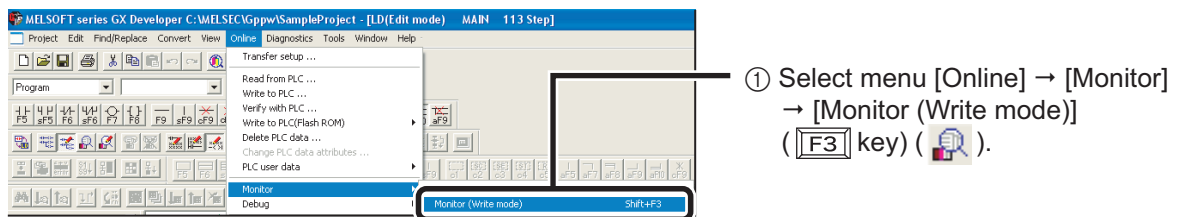

* The "Entry data monitor" screen can be displayed by selecting [Entry data monitor] with a right click on the ladder screen.

To the next page

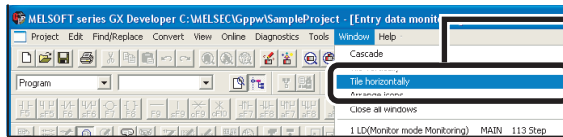

③ Select [Window] → [Tile horizontally].

* Set the "Entry data monitor" screen to the monitor stop status.



The ladder screen and the "Entry data monitor" screen are displayed horizontally.

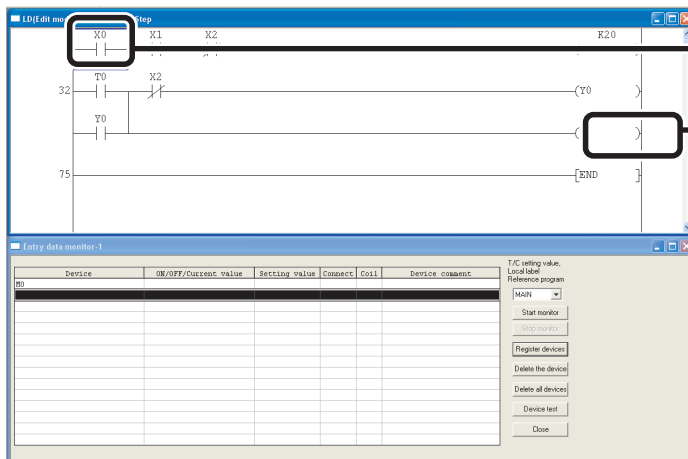

④ Click the start point of the ladder.

⑤ Click the end point of the ladder while pressing the **Shift** key (specify the range).



Register devices to the "Entry data monitor" screen.

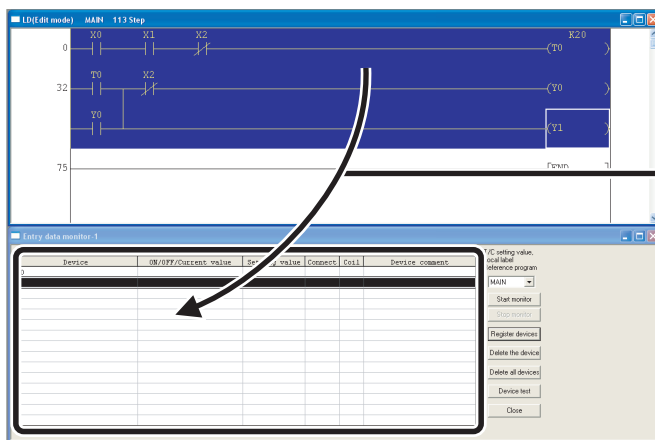

⑥ Drag and drop the selected range to the "Entry data monitor" screen.



The values of the selected devices are monitored.

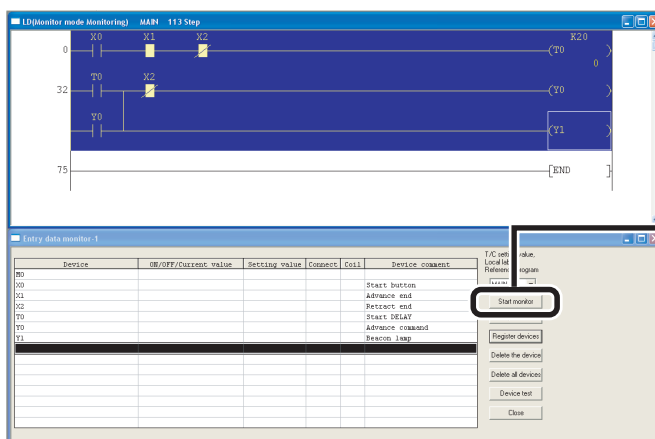

⑦ Click the **Start monitor** button.

■ Changing device values <Device test>

This function forces bit devices (such as X, Y, M, C) of the CPU module ON/OFF, or changes the current value of the word device (such as T, C, D) to the specified value.

● Bit device forced ON/OFF

Forcing bit devices (such as X, Y, M, C) of the CPU module ON/OFF.

Operating procedure

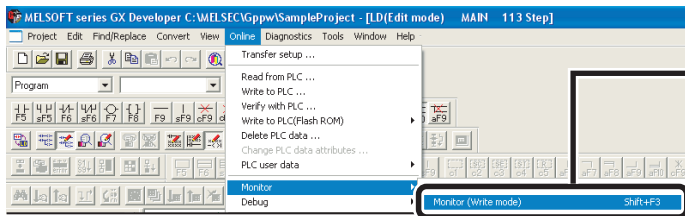

① Select [Online] → [Monitor] → [Monitor (Write mode)] ([F3] key) ([Monitor icon]).

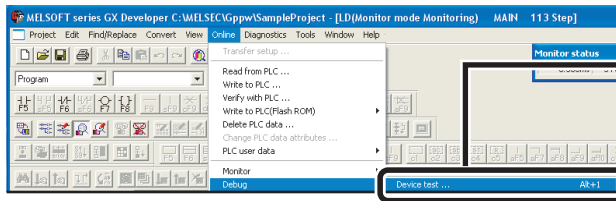

② Select [Online] → [Debug] → [Device test] ([Alt] key + [1] key).

* The "Device test" screen can be displayed by selecting [Device test] with a right click on the ladder screen.

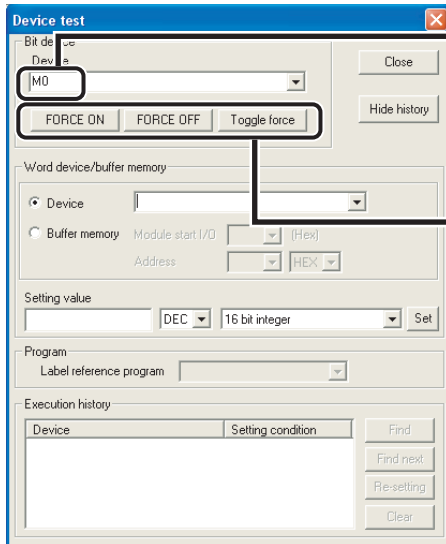

③ Enter the device number to be forced ON/OFF.

④ Force the device ON/OFF

FORCE ON : Force the device ON.

FORCE OFF : Force the device OFF.

Toggle force : Force the device ON/OFF with each click.



● Forcing a bit device ON/OFF with the key operation

Double-click the specified bit device on the ladder monitor screen while pressing the [Shift] key to force it ON/OFF.

- **Word device current value modification**

Changing the current value of the word device (such as T, C, D) in the CPU module to the specified value.

Operating procedure

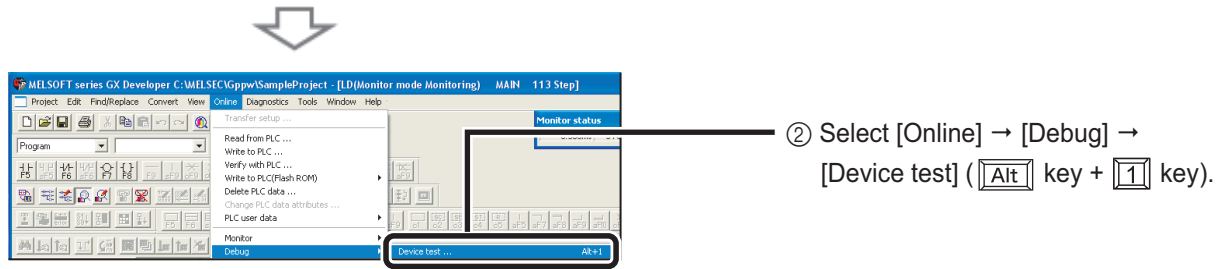
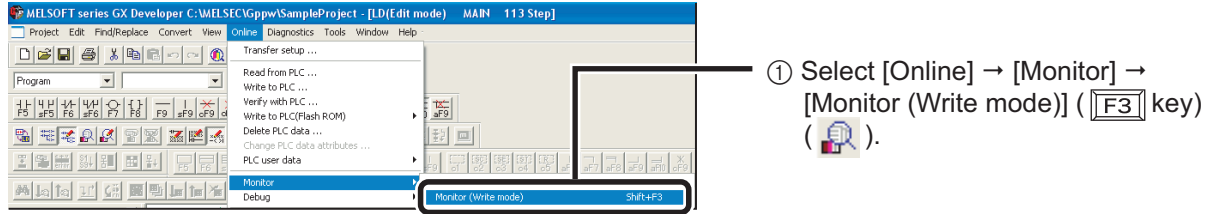

* The "Device test" screen can be displayed by selecting [Device test] with a right click on the ladder screen.

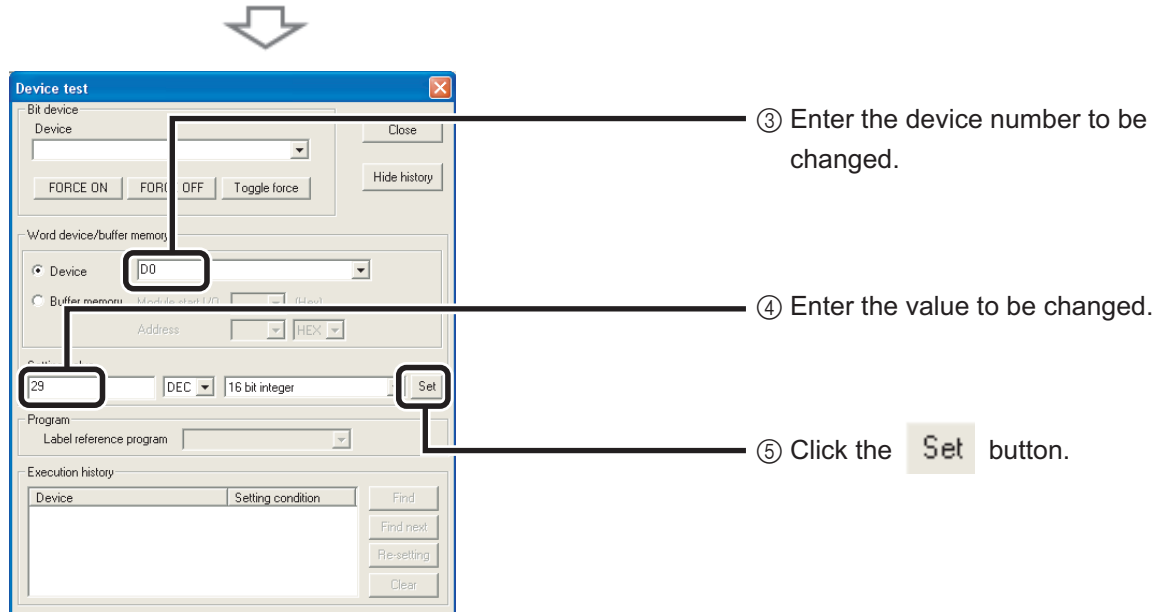

■ Changing running programs <Online program change>

This function writes only the modified ladder block to the CPU module while the CPU module is in the "RUN" status.

A program can be written in a short time since this function does not transfer the whole program.

The following is an example of adding a contact to the ladder.

Operating procedure

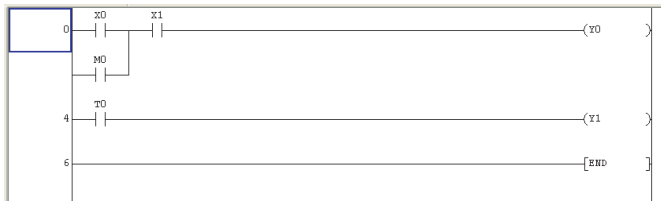

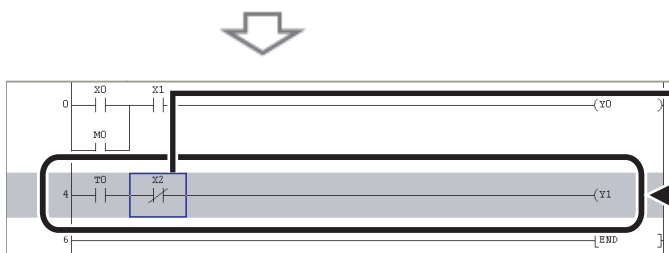

- ① Select ( Write mode) while displaying the ladder.

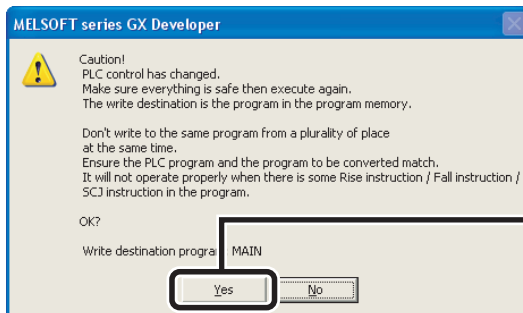

- ② Add a contact.

The ladder block is displayed in gray.



- ③ Select [Convert] → [Convert (Online change)] ( Shift key +  F4 key).

- ④ Click the **Yes** button.

When the online program change has been properly completed, the following message is displayed.

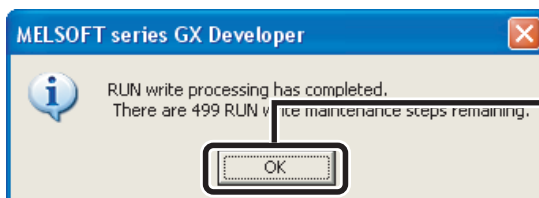

- ⑤ Click the **OK** button to close the screen.

Caution

The program in the CPU module and the program to be modified in GX Developer must be the same to perform the online program change. When you are not sure, verify the programs in advance or modify the ladder after performing the "Read from PLC" function.

■ Monitoring system status <System monitor>

This function monitors the system status of the CPU module and other modules.

Operating procedure

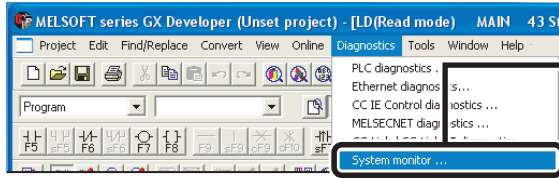

Select menu [Diagnostics] → [System monitor].



The "System Monitor" screen is displayed.

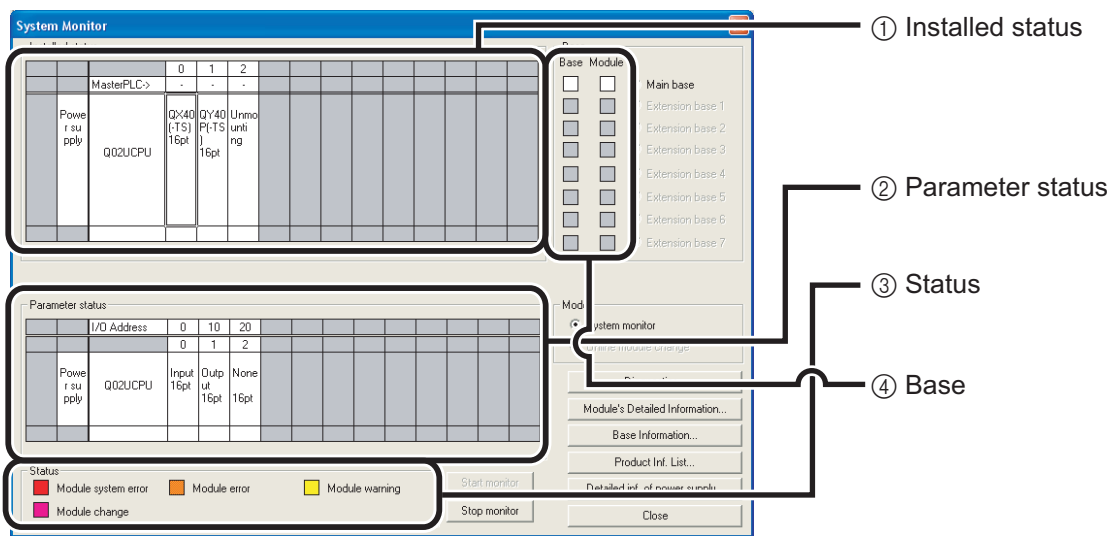

No.	Description
①	Installed status: Displays the modules installed on the base unit.
②	Parameter status: Displays the parameter setting status written to the CPU module.
③	Status: Classifies error status of ④ by color.
④	Base: Displays the normal status in white and abnormal in red. Module: Displays the error status with the color in ③.

- The information of each module can be checked from the "System Monitor" screen.

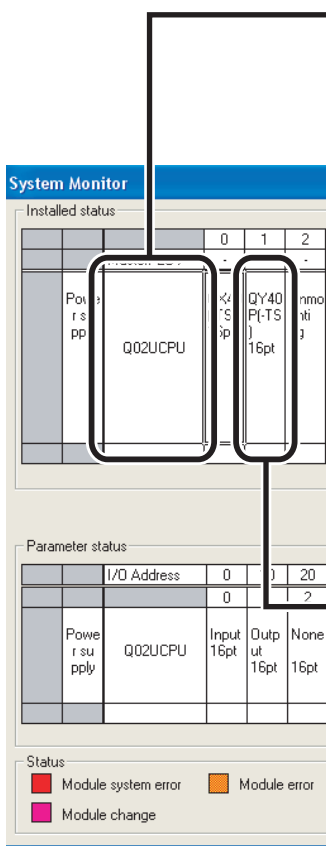

Double-click the CPU module.

→ The "PLC diagnostics" screen is displayed to check the operation status of the CPU module.

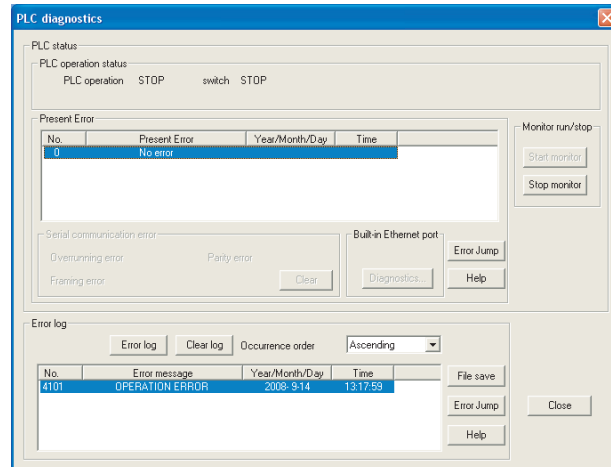

Double-click each module (except the CPU module and power supply module).

→ The "Module's Detailed Information" screen is displayed to check the status of each module.

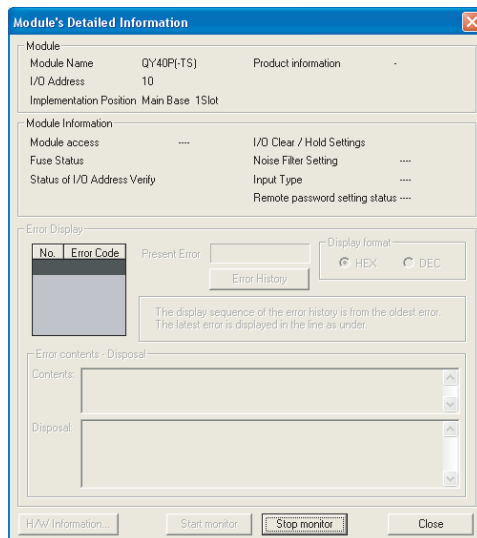

Microsoft, Windows, Windows NT, and Windows Vista are registered trademarks or trademarks of Microsoft Corporation in the U.S. and other countries.

Ethernet is a trademark of Xerox Corporation in the U.S.

Other corporate and product names in the manual may be trademarks or registered trademarks of their respective companies.

Precautions for Choosing the Products

This publication explains the typical features and functions of the Q Series programmable controllers and does not provide restrictions and other information on usage and module combinations. When using the products, always read product user manuals.

Mitsubishi Electric will not be held liable for damage caused by factors found not to be the cause of Mitsubishi Electric; opportunity loss or lost profits caused by faults in Mitsubishi Electric products; damage, secondary damage, accident compensation caused by special factors unpredictable by Mitsubishi; damages to products other than Mitsubishi Electric products; and to other duties.

For safe use

- To use the products given in this publication properly, always read the "manuals" before starting to use them.
- The products have been manufactured as general-purpose parts for general industries, and have not been designed or manufactured to be incorporated in a device or system used in purposes related to human life.
- Before using the products for special purposes such as nuclear power, electric power, aerospace, medicine or passenger movement vehicles, consult with Mitsubishi.
- The products have been manufactured under strict quality control. However, when installing the products where major accidents or losses could occur if the products fail, install appropriate backup or failsafe functions in the system.

Mitsubishi Programmable Controller

Country/Region	Sales office	Tel/Fax
USA	MITSUBISHI ELECTRIC AUTOMATION, INC. 500 Corporate Woods Parkway, Vernon Hills, IL 60061, U.S.A.	Tel : +1-847-478-2100 Fax : +1-847-478-2253
Mexico	MITSUBISHI ELECTRIC AUTOMATION, INC. Mexico Branch Mariano Escobedo #69, Col. Zona Industrial, Tlalnepantla Edo, C.P.54030, Mexico	Tel : +52-55-3067-7500
Brazil	MITSUBISHI ELECTRIC DO BRASIL COMÉRCIO E SERVIÇOS LTDA. Rua Jussara, 1750-Blcco B Anexo, Jardim Santa Cecilia, CEP 06465-070, Barueri-SP, Brasil	Tel : +55-11-4689-3000 Fax : +55-11-4689-3016
Germany	MITSUBISHI ELECTRIC EUROPE B.V. German Branch Gothaer Strasse 8, D-40880 Ratingen, Germany	Tel : +49-2102-486-0 Fax : +49-2102-486-1120
UK	MITSUBISHI ELECTRIC EUROPE B.V. UK Branch Travellers Lane, Hatfield, Hertfordshire, AL10 8XB, U.K.	Tel : +44-1707-28-8780 Fax : +44-1707-27-8695
Ireland	MITSUBISHI ELECTRIC EUROPE B.V. Irish Branch Westgate Business Park, Ballymount, IRL-Dublin 24, Ireland	Tel : +353-1-4198800 Fax : +353-1-4198890
Italy	MITSUBISHI ELECTRIC EUROPE B.V. Italian Branch Centro Direzionale Colleoni-Palazzo Sirio Viale Colleoni 7, 20864 Agrate Brianza(Milano) Italy	Tel : +39-039-60531 Fax : +39-039-6053-312
Spain	MITSUBISHI ELECTRIC EUROPE, B.V. Spanish Branch Carretera de Rubí, 76-80-Apdo. 420, 08173 Sant Cugat del Vallés (Barcelona), Spain	Tel : +34-935-65-3131 Fax : +34-935-89-1579
France	MITSUBISHI ELECTRIC EUROPE B.V. French Branch 25, Boulevard des Bouvets, F-92741 Nanterre Cedex, France	Tel : +33-1-55-68-55-68 Fax : +33-1-55-68-57-57
Czech Republic	MITSUBISHI ELECTRIC EUROPE B.V. Czech Branch Avenir Business Park, Radlicka 751/113e, 158 00 Praha5, Czech Republic	Tel : +420-251-551-470 Fax : +420-251-551-471
Poland	MITSUBISHI ELECTRIC EUROPE B.V. Polish Branch ul. Krakowska 50, 32-083 Balice, Poland	Tel : +48-12-630-47-00 Fax : +48-12-630-47-01
Sweden	MITSUBISHI ELECTRIC EUROPE B.V. (Scandinavia) Fjellievägen 8, SE-22736 Lund, Sweden	Tel : +46-8-625-10-00 Fax : +46-46-39-70-18
Russia	MITSUBISHI ELECTRIC EUROPE B.V. Russian Branch St. Petersburg office Piskarevsky pr. 2, bld 2, lit "Sch", BC "Benua", office 720; RU-195027 St. Petersburg, Russia	Tel : +7-812-633-3497 Fax : +7-812-633-3499
Turkey	MITSUBISHI ELECTRIC TURKEY A. Ş Ümraniye Branch Serifali Mahallesi Nutuk Sokak No:5, TR-34775 Umraniye, Istanbul, Turkey	Tel : +90-216-526-3990 Fax : +90-216-526-3995
Dubai	MITSUBISHI ELECTRIC EUROPE B.V. Dubai Branch Dubai Silicon Oasis, P.O.BOX 341241, Dubai, U.A.E.	Tel : +971-4-3724716 Fax : +971-4-3724721
South Africa	ADROIT TECHNOLOGIES 20 Waterford Office Park, 189 Witkoppen Road, Fourways, Johannesburg, South Africa	Tel : +27-11-658-8100 Fax : +27-11-658-8101
China	MITSUBISHI ELECTRIC AUTOMATION (CHINA) LTD. No.1386 Hongqiao Road, Mitsubishi Electric Automation Center, Shanghai, China	Tel : +86-21-2322-3030 Fax : +86-21-2322-3000
Taiwan	SETSUYO ENTERPRISE CO., LTD. 6F, No.105, Wugong 3rd Road, Wugu District, New Taipei City 24889, Taiwan, R.O.C.	Tel : +886-2-2299-2499 Fax : +886-2-2299-2509
Korea	MITSUBISHI ELECTRIC AUTOMATION KOREA CO., LTD. 7F-9F, Gangseo Hangang Xi-tower A, 401, Yangcheon-ro, Gangseo-Gu, Seoul 157-801, Korea	Tel : +82-2-3660-9530 Fax : +82-2-3664-8372
Singapore	MITSUBISHI ELECTRIC ASIA PTE. LTD. 307, Alexandra Road, Mitsubishi Electric Building, Singapore 159943	Tel : +65-6473-2308 Fax : +65-6476-7439
Thailand	MITSUBISHI ELECTRIC FACTORY AUTOMATION (THAILAND) CO., LTD. 12th Floor, SV.City Building, Office Tower 1, No. 896/19 and 20 Rama 3 Road, Kwaeng Bangpongpan, Khet Yannawa, Bangkok 10120, Thailand	Tel : +66-2682-6522 Fax : +66-2682-6020
Vietnam	MITSUBISHI ELECTRIC VIETNAM COMPANY LIMITED Hanoi Branch 6-Floor, Detech Tower, 8 Ton That Thuyet Street, My Dinh 2 Ward, Nam Tu Liem District, Hanoi, Vietnam	Tel : +84-4-3937-8075 Fax : +84-4-3937-8076
Indonesia	PT. MITSUBISHI ELECTRIC INDONESIA Gedung Jaya 11th Floor, JL. MH. Thamrin No.12, Jakarta Pusat 10340, Indonesia	Tel : +62-21-3192-6461 Fax : +62-21-3192-3942
India	MITSUBISHI ELECTRIC INDIA PVT. LTD. Pune Branch Emerald House, EL-3, J Block, M.I.D.C Bhosari, Pune-411026, Maharashtra, India	Tel : +91-20-2710-2000 Fax : +91-20-2710-2100
Australia	MITSUBISHI ELECTRIC AUSTRALIA PTY. LTD. 348 Victoria Road, P.O. Box 11, Rydalmere, N.S.W 2116, Australia	Tel : +61-2-9684-7777 Fax : +61-2-9684-7245

Mitsubishi Electric Corporation Nagoya Works is a factory certified for ISO 14001 (standards for environmental management systems) and ISO 9001 (standards for quality assurance management systems)

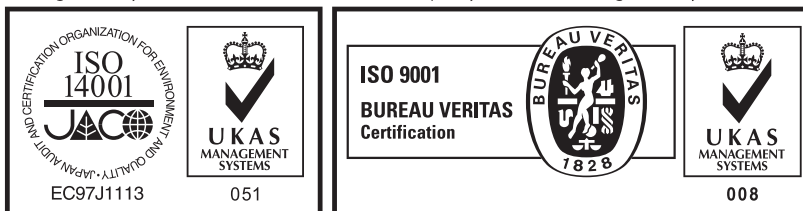

MITSUBISHI ELECTRIC CORPORATION

HEAD OFFICE: TOKYO BUILDING, 2-7-3, MARUNOUCHI, CHIYODA-KU, TOKYO 100-8310, JAPAN
NAGOYA WORKS: 1-14, YADA-MINAMI 5, HIGASHI-KU, NAGOYA, JAPAN